

 SilensPRO®  
**REVOLUTION NANO**

 SilensPRO®  
**REVOLUTION MICRO**



**100-630 Kg**

Machine-roomless lifts

## Here it is: a major revolution in machine-roomless lifts.

In 1997 we designed and built our first machine-roomless lift with a gearless permanent-magnet drive unit, forging ahead of the overwhelming majority of our competitors. After two decades of constant development and innovation, and the installation of thousands of lift systems across five continents, we have taken another major step forward with the **Silens Pro Revolution®** - a range of state-of-the-art machine-roomless lifts **with a rated load of anything from 100Kg to 1000Kg** that is destined to radically transform the lift industry.

# Contents index

<b>Revolutionary in...</b>	3
<b>Freeing up space in existing buildings</b>	4
<b>High standards on a global scale</b>	5
<b>Single-phase version</b>	6
<b>Varispeed</b>	7
<b>Intelligent technology</b>	8
<b>Modern design - all to the customer's taste</b>	9
200 Revolution Series	10
300 Revolution Series	11
Car wall panels	12
Floors	12
Car operating panels, landing push stations & indicators	13
Handrails	13
Lighting	13
Displays	14
<b>The best possible choice for lift professionals</b>	15
<b>Altamira II control system</b>	16
<b>Technical information</b>	18



## Technological terms



**Silens Pro Revolution®** is the first MRL lift that operates with the new **ALEC system (Automatic Learning Elevator Control)**.

ALEC is a new technological concept based around the *machine learning* concept which gives the lift a new level of intelligence never seen before.

- ✓ **VARISPEED**  
Brand-new technology that converts the **Silens Pro Revolution®** in to the first lift on the market that travels faster than its nominal speed..
- ✓ **SIRES (Shaft Intelligent Revolutionary Elevator System)**  
A concept based on a PESSRAL device with an electronically activated overspeed governor, electromechanical safety gear and absolute positioning that:
  - Guarantees maximum **safety** of passengers.
  - Allows **automatic shaft learning**, drastically reducing commissioning costs.
- ✓ **DIRECT APPROACH SYSTEM**  
Guarantees the smoothest and most precise ride on every single trip.
- ✓ **SMARTTECH CAR AND LANDING INDICATORS**  
New 7" car and landing indicators that keep passengers up to date in real time regarding their trip.



## Simplifying lift engineer tasks

The **ALEC system** includes new features specifically designed for lift professionals:

- ✓ **New App** designed by lift engineers for lift engineers to facilitate maintenance and technical support tasks.
- ✓ Maximum simplicity thanks to the latest **Plug and Play** technology (pre-wired and pre-tested) as well as **Quick Spin** technology that instantly synchronises the gearless machine and drive removing expensive commissioning costs.

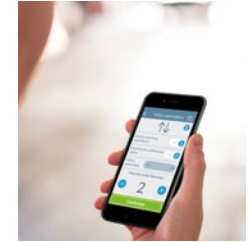

## Its energy-efficiency

Our **Silens Pro Revolution®** lifts have been awarded the maximum possible energy-efficiency ratings according to the VDI 4707 and ISO 25745-2 standard.

- ✓ The incorporation of **Varispeed** and the **Direct Approach System**.
- ✓ The **gearless drive unit** significantly lowers energy consumption and does not require lubricants.
- ✓ **Stand-by mode** is activated whenever the lift is not in use.
- ✓ Energy-efficient lighting with **LED spotlights**.
- ✓ Designed and built in compliance with **ISO 14001**, the international standard which sets the basis for an **effective environmental management system**.

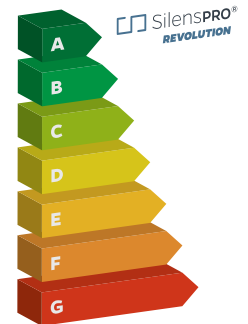



# Freeing up space in existing buildings

With the **Silens Pro Revolution Nano® (100Kg-320Kg)** and the **Silens Pro Revolution Micro® (375Kg-630Kg)**, the breakthrough technology of the **Silens Pro Revolution** range is now available for the transformation of existing buildings: strikingly versatile, these two cutting-edge lift systems are perfect for installation in shafts of limited dimensions or as a replacement for outdated lifts, offering a range of sizes and configurations that is unique in the market.



The **Silens Pro Revolution Nano®** and the **Silens Pro Revolution Micro®** have been specially designed so that the mechanical components of the system take up less space inside the shaft, which enables passengers to enjoy roomier, more spacious lift cars. As a result, in standard-sized shafts, **the Silens Pro Revolution Nano® and the Silens Pro Revolution Micro® allow one more person to travel than other lifts available on the market.**

SHAFT DIMENSIONS *	OTHER LIFTS			SPR NANO & MICRO		
	Load	People	Clear opening (C/O)	People	Load	Clear opening (C/O)
1300x1350	320kg	4	2P 700	+ 5	375kg	2P 750
1350x1500	375kg	5	2P 700	+ 6	450kg	2P 800
1500x1600	450kg	6	2P 800	+ 8	630kg	2P 850
1500x1750	525kg	7	2P 800	+ 8	630kg	2P 850

The information shown is for single entry lifts with automatic 2 panel side opening doors.

- ✓ In full accordance with the EN 81-21 standard, The **Silens Pro Revolution Nano®** and the **Silens Pro Revolution Micro®** can be installed in **shafts with a reduced-size pit.**
- ✓ On top of that, their revolutionary design allows **wider door clearances** than other lifts in the same-sized shafts, making passenger access to the car easier and less restricted.
- ✓ The **Silens Pro Revolution Nano®** and the **Silens Pro Revolution Micro®** can be installed inside **traditional masonry-built** shafts as well as in the interior of **prefabricated modular structures.**
- ✓ Where there is a **through car-entrance configuration**, different door types can be installed at the two entrances, making these lift solutions **supremely flexible** when it comes to matching a building's particular needs and design aesthetic.

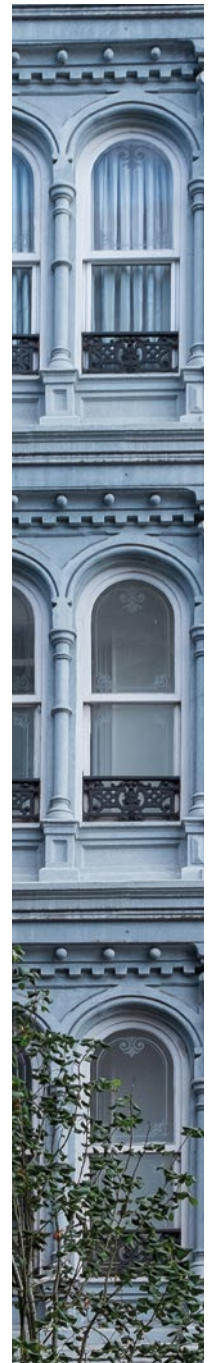

# High standards on a global scale

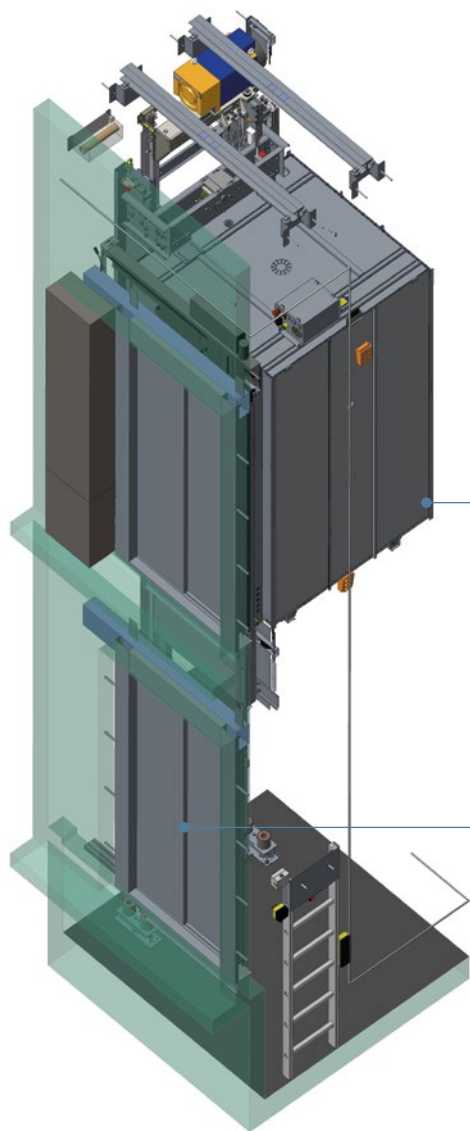

The platform, flooring and roofing of the **lift car**, together with its sling, are built of high-strength galvanised steel to form a very robust unit.

**Automatic fire-rated doors**, side or central opening are safe and reliable. Available in brushed stainless steel or epoxy finish. Other door types and models are also available.

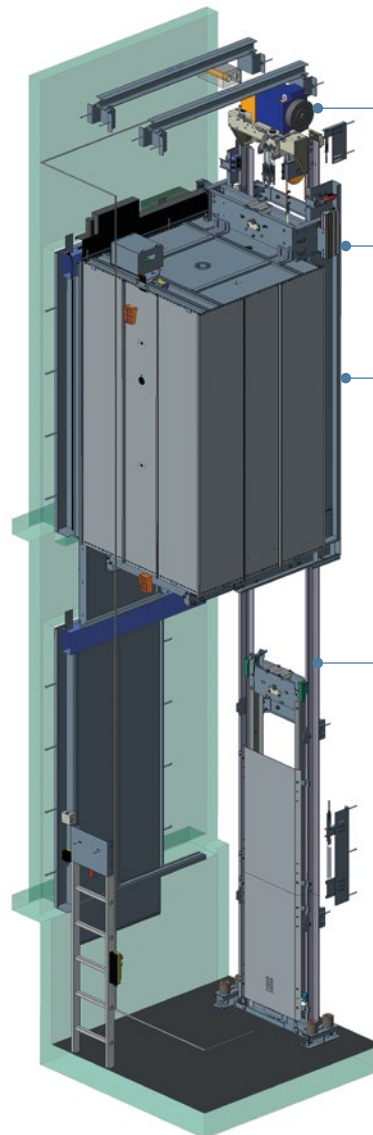

**Gearless machine: compact & energy efficient** as well as easier to install due to its reduced weight.

State-of-the-art **electronic overspeed governor**.

**Ultra-rigid and lightweight cantilever** sling made of high-strength steel that allows for an extensive range of opening configurations. A modern electrically activated safety gear replaces the traditional linkage bar arrangement between traditional safety gear blocks.

The **machined guide rails** are of the highest quality and are delivered cut to size to suit the particular project.

In-shaft safety devices (limit switches, absolute positioning, door zone magnets, final limits) are integrated into a PESSRAL device.



## SPR Nano<sup>®</sup> and SPR Micro<sup>®</sup> also in the single-phase version

**Silens Pro Revolution Nano & Micro<sup>®</sup>** are available for single-phase buildings across the whole load range simplifying the steps needed for installation.

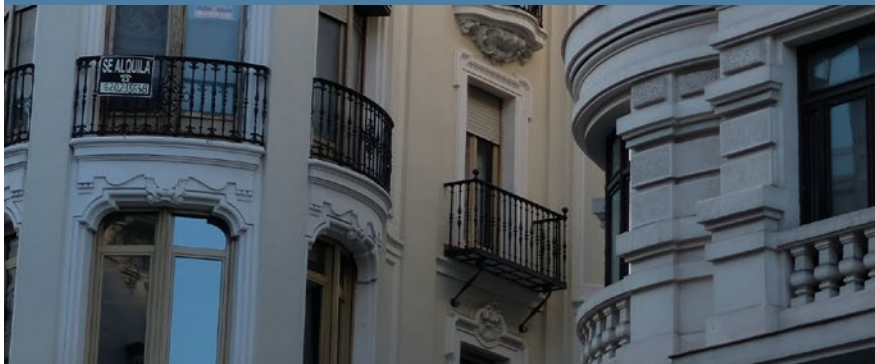

As easy as  
installing,  
plugging in  
and... ready



### Minimum building requirements

**Silens Pro Revolution Nano & Micro<sup>®</sup>** can be connected directly to the building's single-phase 220V electrical grid, thereby reducing the cost of installation and launch.



### Less paperwork

Property owners will be grateful for **not having to register the building for three-phase power** with their energy company.



### The quickest of their class

Thanks to Varispeed technology, cars can reach a speed of **1 m/s without increasing power consumption**, depending on the number of passengers.



### Always available

**They do not rely on the charging level of traditional batteries**; they are powered directly from the electrical grid instead.





# Varispeed: Faster travel for optimum traffic .

For the first time as standard, the **Silens Pro Revolution®** incorporates groundbreaking **Varispeed** technology that allows the lift to travel faster, to cut passengers' travel and waiting times and to increase lift traffic capacity in the building.

Varispeed allows lifts to travel faster than their rated speed.

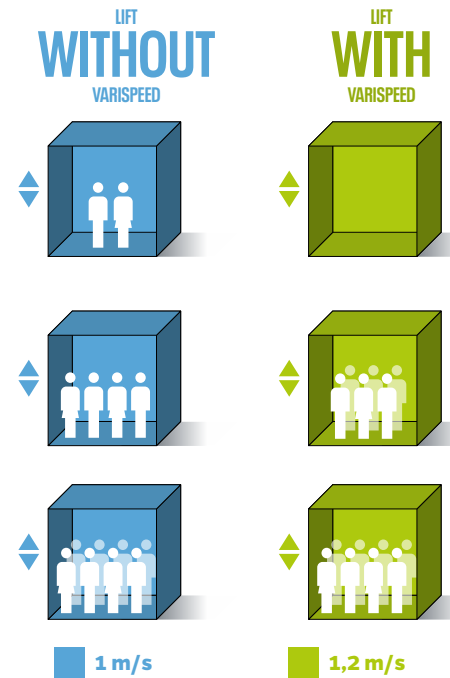

Travel up to **20% faster.**



Reduction of waiting times.\*



Reduced energy consumption.\*\*



Reduced travel time to destination.\*\*\*



\* & \*\*\*: based on traffic analysis during the late evening in a residential building with 24m travel, 9 floors and an occupation of 10 people per floor.

\*\* : based on data collected of random traffic in a residential building over 6 floors with 15.5m travel.



## Intelligent technology

Every **Silens Pro Revolution®** is an integrated system, made up of interconnected components which communicate in real time improving levels of safety, client's experience, installation process and maintenance tasks.



### Direct Approach System

Our **Direct Approach System** allows the lift's control system to calculate the optimum speed curve for each trip, avoiding the delays typically experienced with lifts that do not benefit from this function.

As a result, lift travel and waiting times are drastically reduced and passenger experience in terms of comfort, smoothness of travel and car-to-landing stopping accuracy are significantly improved.

On top of that, the Direct Approach System gets rid of the need for a series of sensors and devices inside the lift shaft, thereby simplifying, shortening and economising on the lift installation process and subsequent maintenance work.

### SIRES, Intelligence reinvented

For the first time, **Silens Pro Revolution®** includes as standard **SIRES (Shaft Intelligent Revolutionary Elevator System)**. The concept is based around a PESSRAL\* device providing absolute positioning in the lift shaft using the latest magnetic tape technology.

**SIRES** provides continuous real-time information on the lift car's location in the shaft, precise to within less than 1mm. **SIRES** allows us to optimise electromagnetic devices and delivers many other benefits (see adjacent box).

#### WHAT DOES SIRES PROVIDE?

- ✓ **Automatic shaft learning** drastically reducing installation costs.
- ✓ **Installation & maintenance:** faster, easier and more adaptable.
- ✓ **Lift car location:** always available in real time.
- ✓ **Fault detection:** made simpler by its advanced diagnostic capacities and the removal of outdated components.
- ✓ **Covers various safety functions** of the EN81-20 / 50 standard such as bottom limits, uncontrolled movement, overspeed control and triggering.
- ✓ It also covers other safety functions such as door area positioning for the emergency rescue control system.
- ✓ The PESSRAL device is **silent and resistant to dust, smoke and humidity**.

\* The PESSRAL system is designed for control, protection or monitoring based on one or more programmable electronic devices, including all elements of the system such as power supplies, sensors and other input devices, data highways and other communication paths, and actuators and other output devices, used in safety related applications.



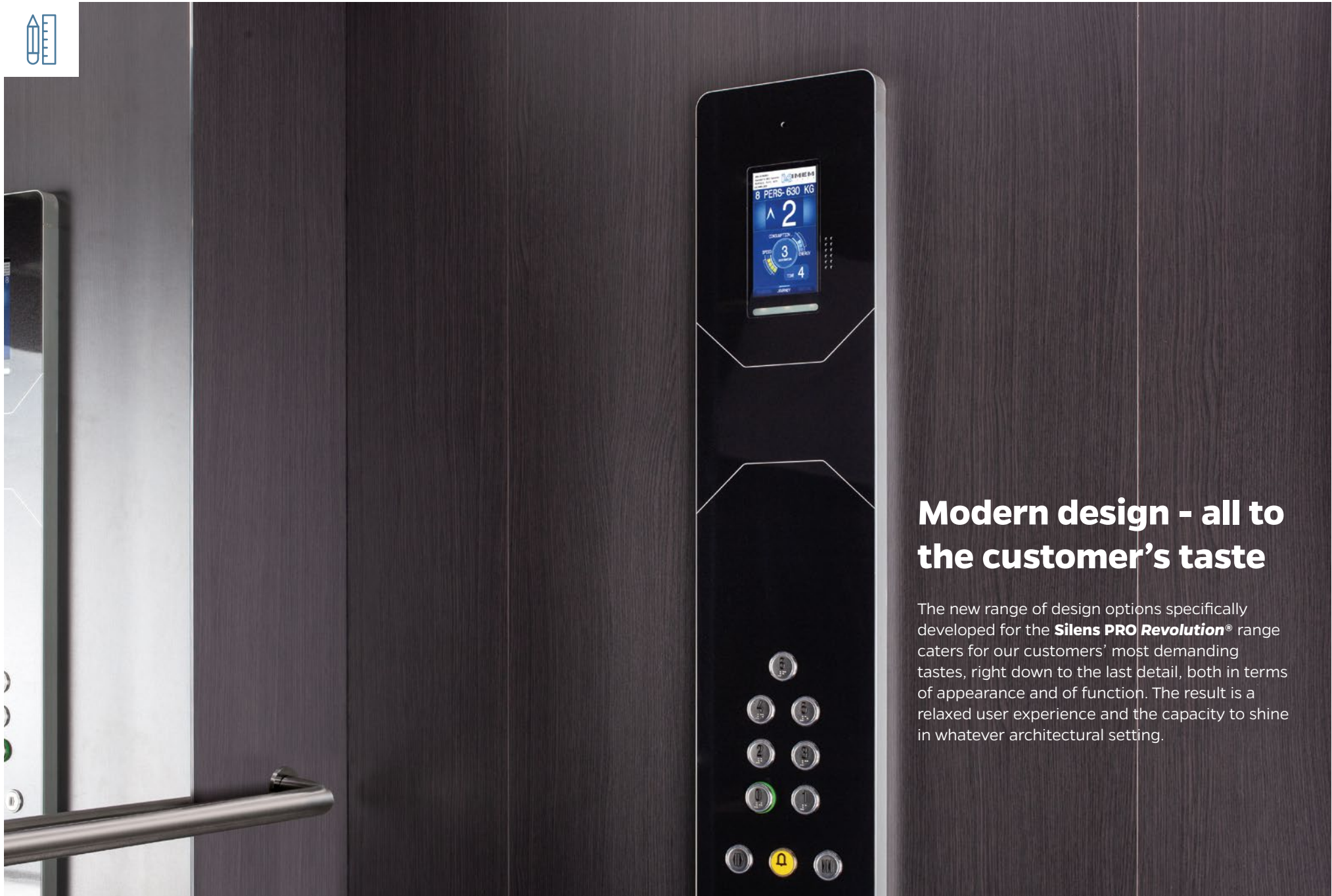

## Modern design - all to the customer's taste

The new range of design options specifically developed for the **Silens PRO Revolution®** range caters for our customers' most demanding tastes, right down to the last detail, both in terms of appearance and of function. The result is a relaxed user experience and the capacity to shine in whatever architectural setting.



## 200 Revolution Series

**200 Revolution Series** lift cars are built with galvanised steel sheeting and clad with plastic laminates available in a wide range of colours or with stainless steel in a choice of different patterns.

- ✓ **In-car lighting:** direct, using LED spotlights from either range.
- ✓ **Lift-car doors and front returns:** finished in stainless steel.
- ✓ **Car operating panel:** BCR 1 model which includes the 7" TFT colour indicator.
- ✓ Hard-wearing **car floors** available in a range of rubber finishes. Other finishes available on request.
- ✓ **Handrails** (optional): finished in AISI 304 stainless steel. Lift car is also available with handrails on all walls or without.
- ✓ **Mirror** (optional): covering half of the back wall of the car.
- ✓ Design in full accordance with 2014/33/EU Directive, EN 81-20:2014, EN 81-50:2014 and EN 81-70:2018.

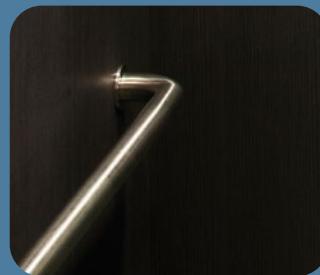

## 300 Revolution Series

**300 Revolution Series** lift cars are built with galvanised steel sheeting and clad with high-pressure laminates in a wide range of colours.

- ✓ **In-car lighting:** direct, using LED spotlights from either range.
- ✓ **Lift-car doors and front returns:** finished in stainless steel.
- ✓ **Car operating panel:** BCR 2 model which includes the 7" TFT colour indicator.
- ✓ **Skirtings:** finished in aluminium.
- ✓ Hard-wearing **car floors** available in a range of rubber finishes. Other finishes available on request.
- ✓ **Handrails** (optional): finished in AISI 304 stainless steel. Lift car is also available with handrails on all walls or without.
- ✓ **Mirror** (optional): covering two-thirds of the car's back wall.
- ✓ Design in full accordance with 2014/33/EU Directive, EN 81-20:2014, EN 81-50:2014 and EN 81-70:2018.

Lift car's real internal dimensions with decoration 300 will be less than what shown in our drawings/charts.

EN81:20, EN 81:70 and AS1735-12 norms state that internal lift car measurements are to be calculated between structural walls, allowing surface reductions caused by the different wall finishes. 300R's decoration complies with the above mentioned norms.

# Car wall panels

## 200 Revolution® series · Skinplate

Light Reflectance Value



## 200 Revolution® series · Stainless steel

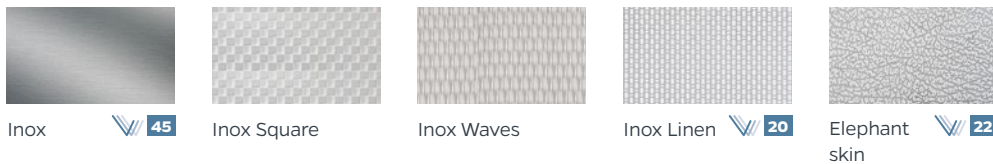

## 300 Revolution® series · High-pressure laminates

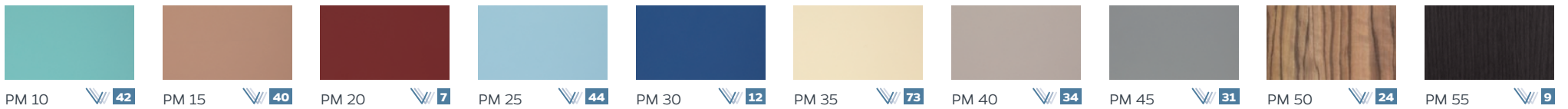

Silens Pro Revolution Nano® | Silens Pro Revolution Micro®

# Flooring

## Rubber

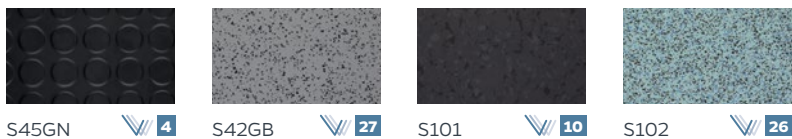

## Granite

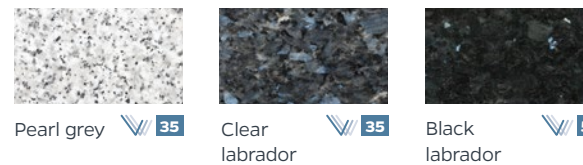

## Marble

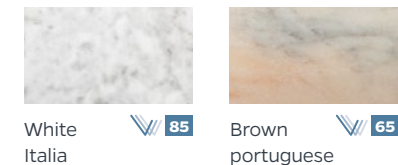

Local flooring preparation 25mm available on request.



# Car operating panels, landing push stations & indicators

## Car operating panels



BCR1 18

BCR2 18

## Car push-buttons

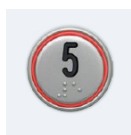

Stainless steel push-buttons with tactile legend and braille (EN 81-70 compliant).

PCEB

## Landing push stations



BER1\*

BER2\*\*

BER3\*\*\*

- \* Push buttons installed directly in the door frame.
- \*\* Flush mounted on door frame.
- \*\*\* Surface mounted on door frame.

## Landing push buttons



PEEB

## Landing indicators



FERV



Smarttech HR 7" indicator. EN 81-70 option: Includes for direction of travel arrow and gong.



HLER - Car doorjamb (EN 81-70)



# Handrails



PSR



# Lighting

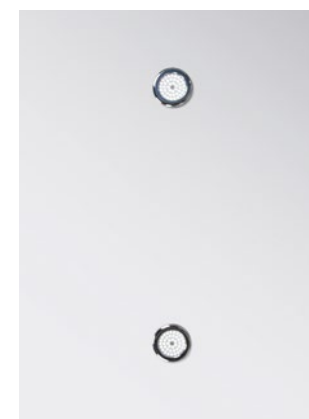

Spot LED

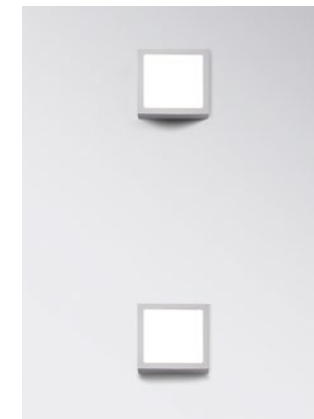

Spot LED square



### Lift car Smartech display



#### Lift availability before travel

The screen tells you if the lift is available for use.

#### Smartech AutoTest Function

Checks and displays the correct functioning of the safety components and system before the start of each journey.

#### Position & direction

Shows the location of the lift within the building at all times, as well as direction of travel.

#### Destination floor & time remaining before arrival

Indicates the floor to which the lift is travelling and the time remaining before arrival, expressed in seconds.

#### Speed

Passengers are kept informed in real time of the car's speed on each journey, from departure until arrival at the destination floor.

#### Energy consumption

Indicates if the lift is consuming energy or generating it during travel, thereby reducing the building's operating costs.

#### Arrival at destination floor alert

Informs passengers when the lift reaches the destination floor.

#### Date & time

Displays the time and date in real time.

#### Load & passenger capacity

Indicates the maximum permissible load, in kilograms, and the maximum number of passengers that can travel in the lift car.

### Landing Smartech HR Display\*



 Includes voice synthesiser!

#### Welcome messages

The screen greets passengers with messages corresponding to the particular time of day.

#### Position & direction

Indicates to passengers waiting on a landing the location of the car and its direction of travel in real time.

#### Flashing LED display by the lift entrance

Alerts passengers to the imminent arrival of the lift.

#### Situation reports

The display transmits relevant information to passengers: such as when there are too many people in the lift car, when the lift door is blocked and when people are entering or leaving the car, among others.

#### Lift arrival countdown

The display shows a progress bar and countdown in seconds, accurately updated in real time, so that passengers know exactly when their lift will arrive.

#### Energy consumption

Indicates if the lift is consuming energy or generating it during travel, thereby reducing the building's operating costs.

#### Voice messages

The screen device shares travel information with passengers via a voice synthesiser built into the door frame. Its volume is automatically adjusted according to the particular time of day.

\*Optional

*All the visual and acoustic messaging has been designed in full accordance with EN 81-70:2018 (Safety rules for the construction and installation of lifts. Particular applications for passenger and goods passenger lifts. Part 70: Accessibility to lifts for persons including persons with disability).*



## The best possible choice for lift professionals

The **Silens Pro Revolution®** has been specifically designed to assist the work of lift professionals throughout the working life of the lift system.

### A fully-integrated solution

The innovative **ALEC system** represents another step in the integration of all electrical and mechanical components of the lift, raising benefits to another level.

### Intelligent packaging

Each lift is delivered on-site in packaging designed to facilitate the work of installation personnel. All the lift components and parts are delivered in a logically-organised series of packs that are clearly identified and strictly ordered according to their place in the installation sequence. The lift system comes with all the parts labelled and numbered and with all the detailed checklists, documents and installation manuals required.

### Fast & straightforward installation

The **Silens Pro Revolution®** can be installed in under 100 hours.

### Plug and Play

Thanks to our Plug and Play manufacturing concept our electrical packages are supplied pre-tested and pre-wired to the specific gearless machine that is shipped with the lift.

### Quick Spin

Instant synchronisation of the gearless machine and VF drive removing expensive commissioning costs.

### Easy to maintain

Maintenance work on a **Silens Pro Revolution Nano®** or **Micro®** lift system by the qualified service technician is safe, quick and supremely straightforward.

### Permanent technical support service

We offer clients all the technical support they require, whether mechanical or electrical: our highly qualified staff advise and assist them in real time and in their own language.

### Spare parts guaranteed

The availability of original spare parts is guaranteed, as is the full traceability of all replacement parts installed.

### Speed of delivery

Once an order has been received and confirmed, the corresponding **Silens Pro Revolution Nano®** or **Micro®** lift system will be delivered within just six weeks.

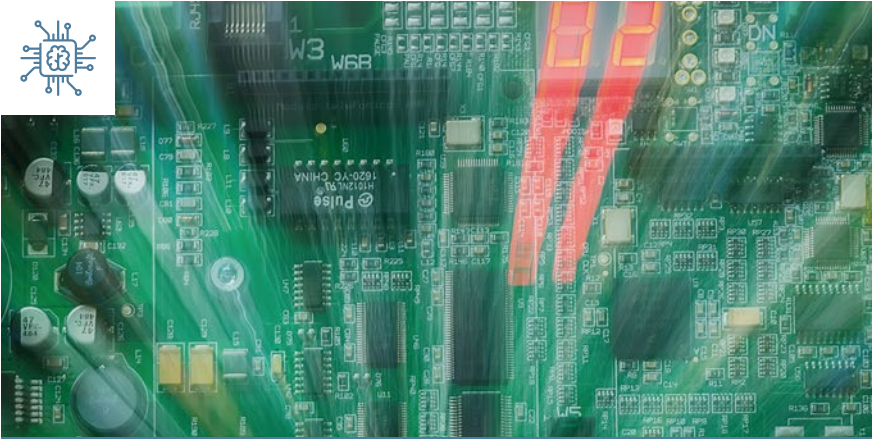

## Altamira II control system: Silens Pro Revolution's® brain

The Altamira II control system has been completely designed and manufactured by IMEM Lifts alone. It was conceived to control, with maximum precision, all the actions of any lift or group of lifts in the **Silens Pro Revolution**® range.

Altamira II is ready to solve, in a simple way, both the most common functions and the most complex and sophisticated, avoiding traditional electro-mechanical solutions.

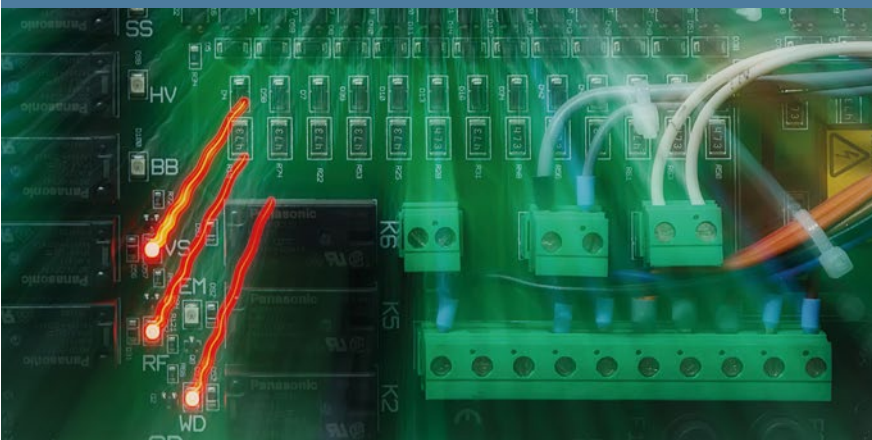

### Seamless integration for perfect performance

- ✓ **Altamira II** is fully integrated with the mechanisms of the entire **Silens Pro Revolution**® lift range. Therefore, in a **Silens Pro Revolution**® lift, the mechanical and the electrical act as one to provide exceptional functionality and performance.
- ✓ **Altamira II** minimises the sensors and components required, making it possible to utilise space to the maximum. It provides optimum travel comfort for the lift and reduces electrical consumption.
- ✓ As electrical and mechanical manufacturers we not only offer our customers lifts that provide integrated electrical and mechanical solutions with perfect compatibility: we also offer integral technical support to our customers, saving time and providing efficient support throughout the lifecycle of our lifts. .

### Easy and quick installation

- ✓ **Altamira II** is supplied pre-assembled, pre-connected and pre-tested which simplifies installation and minimises any margin of error.
- ✓ Perfectly configured inverter and machine operating patterns match the operation of **Altamira II** with the mechanics of every **Silens Pro Revolution**®
- ✓ Installation times are reduced thanks to the almost complete elimination of traditional sensors and magnets.
- ✓ **Altamira II** integrates software that allows a single person to perform a levelling operation in minutes and from inside the lift car.

### Easy maintenance

- ✓ A simple smartphone allows, without the need for cables or additional tools, rapid, easy and user-friendly access to the control system to perform lift maintenance tasks. The **App** provides access to documentation, manuals and communication with our customer support department.
- ✓ In the event of an unexpected anomaly, **Altamira II** will automatically proceed to correct it in a self-learning process by recording the event for later analysis by the maintenance department without interrupting the lift service.
- ✓ Our technical support department can provide remote support and real-time monitoring of lifts via telephone or internet.

### Remote monitoring

- ✓ The remote monitoring system allows lifts installed in one or more buildings to be run from a control room. This system is based on CAN Bus technology that allows monitoring of lifts, detection and reading of faults in real time, control of groups of lifts, analysis of equipment performance and many other functions.







## Operational and service functions

- ✓ **Direct approach**  
The lift approaches the floor with no intermediate speeds to stop gently at the floor level. The position of the car is calculated at all times without the need for magnets.
- ✓ **Homing Mode**  
The lift car returns to the specified homing floor. You can set any floor as the return floor.
- ✓ **Maximum no. of calls**  
Limited number of car calls registered.  
Anti-vandal mode.
- ✓ **Fire control**  
In the event of a fire, a control is activated that sends the lift to the fire emergency floor. If the lift is going away from the fire emergency floor, it will stop at the first possible stop and without opening the doors, it will return to the fire emergency floor. If the lift is going in the direction of the fire emergency floor, it will not stop until it arrives at that floor. This complies with EN81-73. When this movement is completed, it can return to normal operation by means of reset or not.
- ✓ **Stand-by mode**  
Disconnects the lighting inside the car as well as the car and landing displays, thus reducing the electrical consumption of the lift.
- ✓ **Car fan**  
There is a timer to activate/deactivate the fan.
- ✓ **Service control keyswitch**  
Only calls made from the car operating panel are registered.

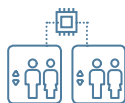

## Multiple movement functions

- ✓ **Multiple**  
A group of up to 4 lifts can be controlled.
- ✓ **Limited out of service**  
Allows a group of lifts to self-manage a singular lift with continuous faults and leave it out of service whilst other lifts handle calls..

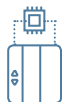

## Door operation functions

- ✓ **Fast closing of doors**  
This allows the time between stops to be shortened by means of a push button in the car that can be activated if there are car calls registered.
- ✓ **Nudge**  
The doors close slowly in the event of a prolonged interruption of the safety edge, notifying the persons in the car visibly and/or acoustically.
- ✓ **Safety edge**  
Safety edge according to EN81-20.
- ✓ **Self-diagnosing safety edge**  
Autodiagnosis of the safety edge in which the door sensors are automatically checked.



## Signalisation and indicator functions

- ✓ **Departure Gong, ascending and descending tones - EN81-70 -**  
Activates a sound with an ascending scale for ascent and a descending scale for descent.
- ✓ **Overload function**  
The display gives a visual and audible indication to the users of overloading inside the car..
- ✓ **Voice synthesizer**  
This is a voice synthesizer that emits informative messages concerning the operation of the lift.



## Emergency operation functions

- ✓ **Manual rescue**  
Manual rescue can be of two types, one by opening the brake and car movement subject to the balance of the car or by means of a high power UPS and directional push buttons that raise or lower the lift.
- ✓ **Emergency ceiling light in car**  
In the event of a power cut, an emergency light in the car operating panel illuminates in accordance with EN81-20.
- ✓ **Automatic rescue device**  
The automatic rescue operation is carried out via a UPS whereby the lift will park at the most favorable floor with the doors open.

# Technical information

## How to use the technical information enclosed within this catalogue.

The **Silens Pro Revolution Nano**® elevators (100Kg-320Kg) and **Silens Pro Revolution Micro**® (375Kg-630Kg) offer a very extensive range of configurations and sizes. In the information enclosed you will find all available configurations for any **Silens Pro Revolution Nano**® or **Silens Pro Revolution Micro**® equipped with automatic 2 panel side opening (Wittur Augusta Evo model) or manual swing doors. There are other door options available: please contact us for further information.

- 01** Choose the door type required and number of openings.
- 02** Check, based on the option chosen in section 01 the technical information tables for the selected product.
- 03** Select the required shaft width and depth from the configuration table. Then check the field "Load" in the lower corner of the page to confirm the final load of the lift based on the dimensions selected as well as the final car dimensions. If your lift is located in an area of the table with pit or headroom restraints these requirements are to be noted.
- 04** Check the door clear opening table to confirm the final door panel and frame size. If your lift has more than one entry, please consult the same dimensions on the table for the alternative 90° or 180° opening.
- 05** In order to confirm that the chosen configuration is feasible, our engineering solution must carry out a final check to confirm the counterweight filler weight balance is correct. If it were not to be viable, we will carry out a technical review to provide an option best suited to your requirements.



## Operational ranges (standard solutions)

<b>Maximum travel</b>	Up to 40 m
	<b>Pit</b>
	<ul style="list-style-type: none"> <li>▶ Minimum: 1050 mm</li> <li>▶ Minimum EN 81-21: 350 mm, optional marble floor</li> <li>▶ Minimum EN 81-21: 320 mm (requires project study and does not include marble floor as an option)</li> <li>▶ Maximum: 1900 mm</li> </ul>
<b>Shaft</b>	<b>Headroom</b>
	<ul style="list-style-type: none"> <li>▶ Minimum (2175mm car): 3600 mm</li> <li>▶ Reduced minimum (2000 mm car): 3400 mm</li> </ul>
	Space required for mechanical elements: 290mm
	*Shaft width: Car width + 350 mm
<b>Lift car construction in 5mm steps</b>	<ul style="list-style-type: none"> <li>▶ Minimum depth: 550 mm</li> <li>▶ Maximum depth: 1450 mm</li> <li>▶ Minimum width: 550 mm</li> <li>▶ Maximum width: 1200 mm</li> <li>▶ Standard height 2175 mm (2000 mm and 2275 mm option in 50mm steps)</li> </ul>

## Mechanical position

### Side

### Doors

### Manual swing+busmatic

### Entrance

### Single 0°

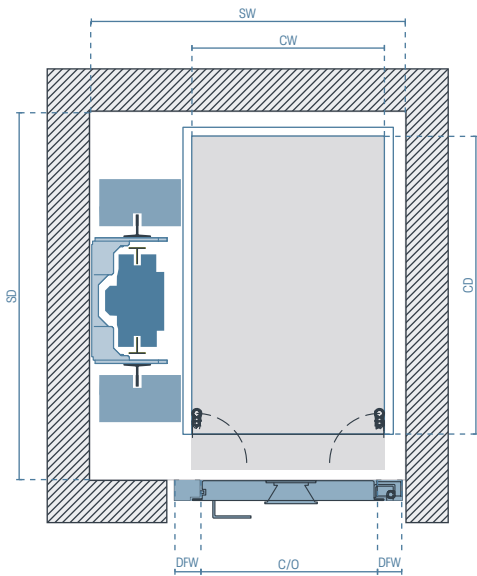

## Car dimensions

### CALCULATION OF CAR DIMENSIONS

**Car width** = Shaft width - 350 mm

**Car depth** = Shaft depth - 200 mm

- ▶ Maximum car width: 1200 mm
- ▶ Minimum car width: 550 mm
- ▶ Maximum car depth: 1450 mm
- ▶ Minimum car depth: 680 mm

**Maximum car area 1,65 m<sup>2</sup>**

Width and depth of car dimensions in 5mm steps

		Shaft width (SW)															
		900	950	1000	1050	1100	1150	1200	1250	1300	1350	1400	1450	1500	1550		
Shaft depth (SD)	+																+
	1650																
	1600																
	1550																
	1500																
	1450																
	1400																
	1350																
	1300																
	1250																
	1200																
	1150																
	1100																
	1050																
	1000																
	950																
925																	
900																	
875																	

## Minimum pit areas

—	1350 mm
All others	1050 mm

- ▶ Minimum reduced pit EN 81-21: 350 mm
- ▶ 320 mm subject to a **technical study**

Clear opening (C/O) Pit >= 750mm	C/O 500	•	••							•••
	C/O 550	•	••							•••
	C/O 600	•	••							•••
	C/O 650	•	••							•••
	C/O 700	•	••							•••
	C/O 750	•	••							•••
	C/O 800	•	••							•••
	C/O 850	•	••							•••
	C/O 900	•	••							•••
	2 Panel side opening doors will fit (please see relevant table)									
Clear opening (C/O) Pit <= 749mm*	C/O 650	••								•••
	C/O 700	•	••							•••
	C/O 750	••								•••
	C/O 800	•	••							•••
	C/O 850	••								•••
C/O 900	•	••							•••	

\* Minimum clear opening (C/O) = 650 mm

## Minimum headroom requirements (car height 2175 mm)

—	4600 mm
All others	3600 mm

## Load

100Kg	180Kg	225Kg	320Kg	375Kg	450Kg	525Kg	630Kg
-------	-------	-------	-------	-------	-------	-------	-------

## Door frame width

- Door frame width (DFW): 75 mm
- Door frame width (DFW): 100 mm
- Door frame width (DFW): 125 mm

## Mechanical position

### Side

### Doors

## Manual swing+busmatic

### Entrance

## Through car 180°

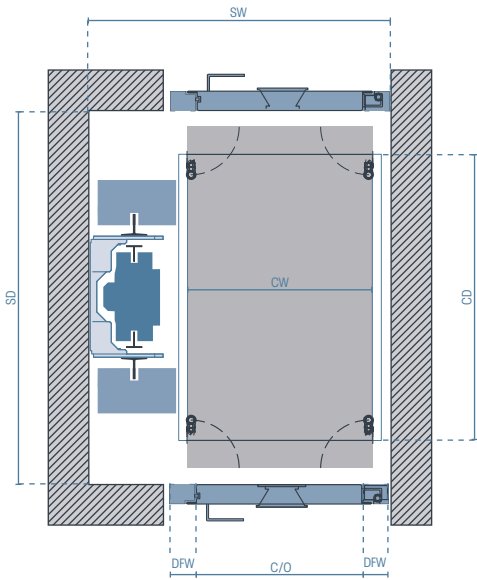

## Car dimensions

### CALCULATION OF CAR DIMENSIONS

**Car width** = Shaft width - 350 mm

**Car depth** = Shaft depth - 260mm

- ▶ Maximum car width: 1200 mm
- ▶ Minimum car width: 550 mm
- ▶ Maximum car depth: 1450 mm
- ▶ Minimum car depth: 720 mm

### Maximum car area 1,65 m<sup>2</sup>

Width and depth of car dimensions in 5mm steps

Shaft depth (SD)	Shaft width (SW)															+	
	900	950	1000	1050	1100	1150	1200	1250	1300	1350	1400	1450	1500	1550			
1700																	1700
1650																	1650
1600																	1600
1550																	1550
1500																	1500
1450																	1450
1400																	1400
1350																	1350
1300																	1300
1250																	1250
1200																	1200
1150																	1150
1100																	1100
1050																	1050
1000																	1000
980																	980

Clear opening (C/O) Pit >= 750mm	Shaft width (SW)														
	900	950	1000	1050	1100	1150	1200	1250	1300	1350	1400	1450	1500	1550	
C/O 500	•	••							•••						
C/O 550	•	••							•••						
C/O 600	•	••							•••						
C/O 650	•	••							•••						
C/O 700	•	••							•••						
C/O 750	•	••							•••						
C/O 800	•	••							•••						
C/O 850	•	••							••				•••		
C/O 900	•	••							•				•••		

2 Panel side opening doors will fit (please see relevant table)

Clear opening (C/O) Pit <= 749mm*	Shaft width (SW)														
	900	950	1000	1050	1100	1150	1200	1250	1300	1350	1400	1450	1500	1550	
C/O 650	••								•••						
C/O 700	•	••							•••						
C/O 750	••								•••						
C/O 800	•	••							•••						
C/O 850	••								••				•••		
C/O 900	•	••							•				•••		

\* Minimum clear opening (C/O)= 650 mm

## Minimum pit areas

—	1350 mm
All others	1050 mm

- ▶ Minimum reduced pit EN 81-21: 350 mm
- ▶ 320 mm subject to a technical study

20

## Minimum headroom requirements (car height 2175 mm)

—	4600 mm
All others	3600 mm

## Load

100Kg	180Kg	225Kg	320Kg	375Kg	450Kg	525Kg	630Kg
-------	-------	-------	-------	-------	-------	-------	-------

## Door frame width

- Door frame width (DFW): 75 mm
- Door frame width (DFW): 100 mm
- Door frame width (DFW): 125 mm

## Mechanical position

### Side

### Doors

### Manual swing+busmatic

### Entrance

### Through car 90° or 270°

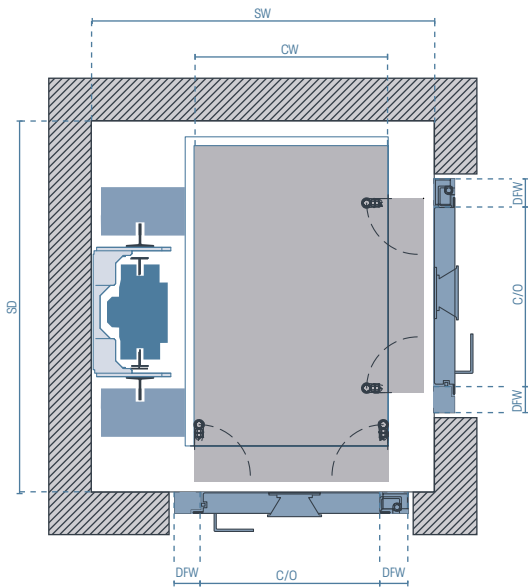

## Car dimensions

### CALCULATION OF CAR DIMENSIONS

**Car width** = Shaft width - 420 mm

**Car depth** = Shaft depth - 200 mm

- ▶ Maximum car width: 1200 mm
- ▶ Minimum car width: 550 mm
- ▶ Maximum car depth: 1450 mm
- ▶ Minimum car depth: 680 mm

**Maximum car area 1,65 m<sup>2</sup>**

Width and depth of car dimensions in 5mm steps

Shaft depth (SD)	Shaft width (SW)													
	970	1000	1050	1100	1150	1200	1250	1300	1350	1400	1450	1500	1550	1600
1650														
1600														
1550														
1500														
1450														
1400														
1350														
1300														
1250														
1200														
1150														
1100														
1050														
1000														
950														
925														
900														
875														

Clear opening (C/O) Pit >= 750mm	Shaft width (SW)													
	970	1000	1050	1100	1150	1200	1250	1300	1350	1400	1450	1500	1550	1600
C/O 500														
C/O 550														
C/O 600														
C/O 650														
C/O 700														
C/O 750														
C/O 800														
C/O 850														
C/O 900														

Clear opening (C/O) Pit <= 749mm*	Shaft width (SW)													
	970	1000	1050	1100	1150	1200	1250	1300	1350	1400	1450	1500	1550	1600
C/O 650														
C/O 700														
C/O 750														
C/O 800														
C/O 850														
C/O 900														

\* Minimum clear opening (C/O) = 650 mm

Clear opening (C/O) Pit >= 750mm	Shaft width (SW)													
	970	1000	1050	1100	1150	1200	1250	1300	1350	1400	1450	1500	1550	1600
C/O 500														
C/O 550														
C/O 600														
C/O 650														
C/O 700														
C/O 750														
C/O 800														
C/O 850														
C/O 900														

## Minimum pit areas

1350 mm
All others 1050 mm

- ▶ Minimum reduced pit EN 81-21: 350 mm
- ▶ 320 mm subject to a technical study

## Minimum headroom requirements (car height 2175 mm)

4600 mm
All others 3600 mm

## Load

100Kg	180Kg	225Kg	320Kg	375Kg	450Kg	525Kg	630Kg
-------	-------	-------	-------	-------	-------	-------	-------

## Door frame width

- Door frame width (DFW): 75 mm
- Door frame width (DFW): 100 mm
- Door frame width (DFW): 125 mm



Mechanical position

## Side

Doors

## 2 panel side opening Augusta EVO

Door mounting position

## Mounted on landings

Entrance

## Single 0°

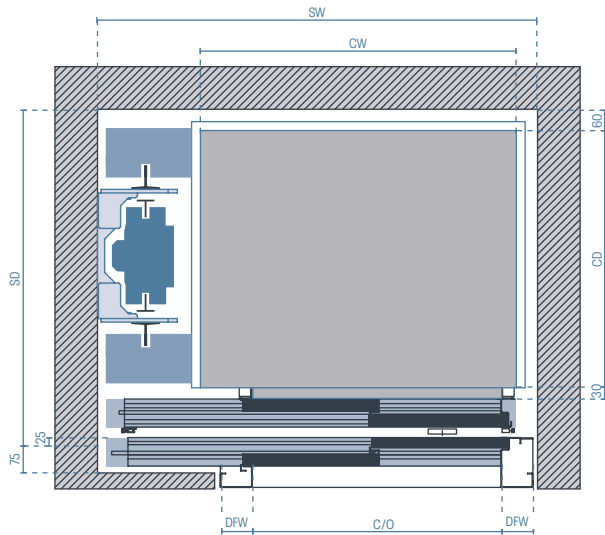

## Car dimensions

### CALCULATION OF CAR DIMENSIONS

**Car width** = Shaft width - 350 mm

**Car depth** = Shaft depth - 225 mm

- ▶ Maximum car width: 1200 mm
- ▶ Minimum car width C/O 700: 850 mm
- ▶ Minimum car width C/O 750: 925 mm
- ▶ Minimum car width C/O 800: 975 mm
- ▶ Minimum car width C/O 850: 1050 mm
- ▶ Minimum car width C/O 900: 1150 mm
- ▶ Maximum car depth: 1450 mm
- ▶ Minimum car depth: 725 mm

**Maximum car area 1,65 m²**

Width and depth of car dimensions in 5mm steps

		Shaft width (SW)							
		1250	1300	1350	1400	1450	1500	1550	+
Shaft depth (SD)	+								+
	1675								
	1650								
	1600								
	1550								
	1500								
	1450								
	1400								
	1350								
	1300								
	1250								
	1200								
	1150								
	1100								
	1050								
1000									
950									
		1250	1300	1350	1400	1450	1500	1550	+

Clear opening (C/O) Pit >= 750mm	C/O 700	•	••	
	C/O 750	•	••	
	C/O 800	•	••	
	C/O 850	•	••	
		C/O 900	•	••

Clear opening (C/O) Pit <= 749mm	C/O 700	•	••	
	C/O 750		••	
	C/O 800	•	••	
	C/O 850		••	
		C/O 900	•	••

## Minimum pit areas

1350 mm
All others 1050 mm

- ▶ Minimum reduced pit EN 81-21: 350 mm
- ▶ 320 mm subject to a technical study

## Minimum headroom requirements (car height 2175 mm)

- ▶ 3600 mm

## Load

225Kg	320Kg	375Kg	450Kg	525Kg	630Kg
-------	-------	-------	-------	-------	-------

## Door frame width

- Door frame width (DFW): 90 mm
- Door frame width (DFW): 120 mm

Mechanical position

## Side

Doors

## 2 panel side opening Augusta EVO

Door mounting position

## Mounted on landings

Entrance

## Through car 180°

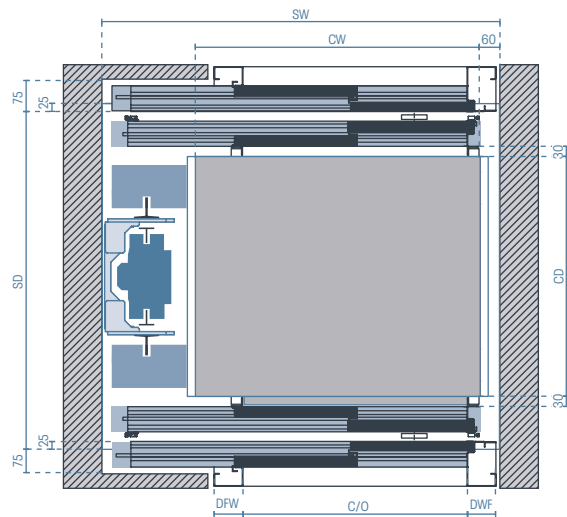

## Car dimensions

### CALCULATION OF CAR DIMENSIONS

**Car width** = Shaft width - 350 mm

**Car depth** = Shaft depth - 330 mm

- ▶ Maximum car width: 1200 mm
- ▶ Minimum car width C/O 700: 850 mm
- ▶ Minimum car width C/O 750: 925 mm
- ▶ Minimum car width C/O 800: 975 mm
- ▶ Minimum car width C/O 850: 1050 mm
- ▶ Minimum car width C/O 900: 1150 mm
- ▶ Maximum car depth: 1450 mm
- ▶ Minimum car depth: 750 mm

**Maximum car area 1,65 m<sup>2</sup>**

Width and depth of car dimensions in 5mm steps

		Shaft width (SW)								
		1250	1300	1350	1400	1450	1500	1550	+	
Shaft depth (SD)	+									+
	1780									
	1750									
	1700									
	1650									
	1600									
	1550									
	1500									
	1450									
	1400									
	1350									
	1300									
	1250									
	1200									
1150										
1100										
1080										
		1250	1300	1350	1400	1450	1500	1550	+	

## Minimum pit areas

1350 mm
All others 1050 mm

- ▶ Minimum reduced pit EN 81-21: 350 mm
- ▶ 320 mm subject to a technical study

Clear opening (C/O) Pit >= 750mm	C/O 700	•	••	
	C/O 750	•	••	
	C/O 800	•	••	
	C/O 850	•	••	
		C/O 900	•	••

Clear opening (C/O) Pit <= 749mm	C/O 700	•	••	
	C/O 750		••	
	C/O 800	•	••	
	C/O 850		••	
		C/O 900	•	••

## Minimum headroom requirements (car height 2175 mm)

- ▶ 3600 mm

## Load

225Kg	320Kg	375Kg	450Kg	525Kg	630Kg
-------	-------	-------	-------	-------	-------

## Door frame width

- Door frame width (DFW): 90 mm
- Door frame width (DFW): 120 mm



Mechanical position

## Side

Doors

## 2 panel side opening Augusta EVO

Door mounting position

## Mounted on landings

Entrance

## Through car 90° or 270°

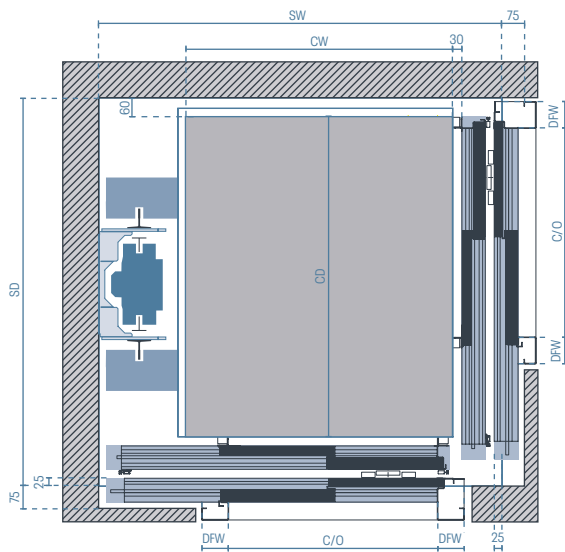

Shaft depth (SD)	Shaft width (SW)						
	1350	1425	1475	1550	1625	1655	
+							+
1675							1675
1650							1650
1600							1600
1550							1550
1500							1500
1450							1450
1400							1400
1350							1350
1300							1300
	1350	1425	1475	1550	1625	1655	
Clear opening (C/O)	C/O 700	•		••			
	C/O 750		•		••		
	C/O 800			•		••	
	C/O 850				•		••
	C/O 900					•	

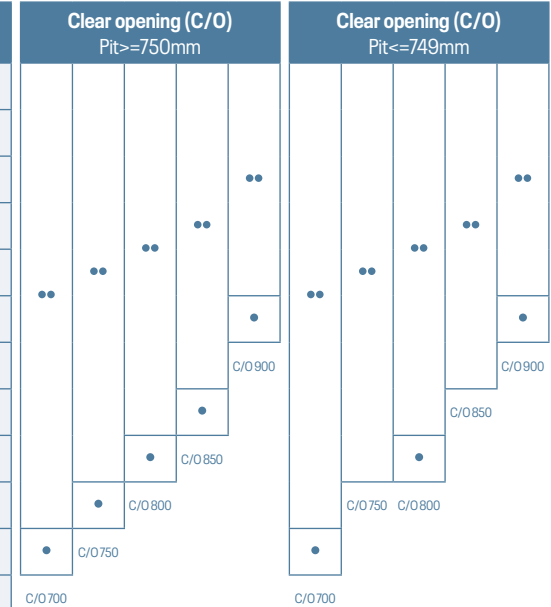

## Car dimensions

CALCULATION OF CAR DIMENSIONS
<b>Car width</b> = Shaft width - 455 mm
<b>Car depth</b> = Shaft depth - 225 mm

- ▶ Maximum car width: 1200 mm
- ▶ Minimum car width C/O 700 (0°): 895 mm
- ▶ Minimum car width C/O 750 (0°): 970 mm
- ▶ Minimum car width C/O 800 (0°): 1020 mm
- ▶ Minimum car width C/O 850 (0°): 1095 mm
- ▶ Minimum car width C/O 900 (0°): 1170 mm
- ▶ Maximum car depth: 1450 mm
- ▶ Minimum car depth C/O 700 (90°): 1075 mm
- ▶ Minimum car depth C/O 750 (90°): 1125 mm
- ▶ Minimum car depth C/O 800 (90°): 1175 mm
- ▶ Minimum car depth C/O 850 (90°): 1225 mm
- ▶ Minimum car depth C/O 900 (90°): 1325 mm

**Maximum car area 1,65 m²**

Width and depth of car dimensions in 5mm steps

## Minimum pit areas

- ▶ 1050 mm
- ▶ Minimum reduced pit EN 81-21: 350 mm
- ▶ 320 mm subject to a technical study

## Minimum headroom requirements (car height 2175 mm)

- ▶ 3600 mm

## Load

320Kg 375Kg 450Kg 525Kg 630Kg

## Door frame width

- Door frame width (DFW): 90 mm
- Door frame width (DFW): 120 mm

Mechanical position  
**Rear mounted**

Doors  
**2 panel side opening Augusta EVO**

Door mounting position  
**Mounted on landings**

Entrance  
**Single 0°**

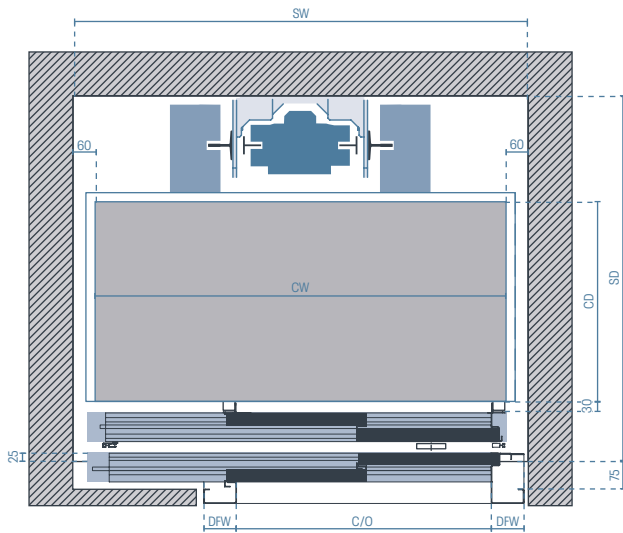

**Car dimensions**

**CALCULATION OF CAR DIMENSIONS**

**Car width** = Shaft width - 120 mm

**Car depth** = Shaft depth - 455 mm

- ▶ Maximum car width: 1450 mm
- ▶ Minimum car width C/O 700: 1130 mm
- ▶ Minimum car width C/O 750: 1180 mm
- ▶ Minimum car width C/O 800: 1230 mm
- ▶ Minimum car width C/O 850: 1330 mm
- ▶ Minimum car width C/O 900: 1430 mm
- ▶ Maximum car depth: 1200 mm
- ▶ Minimum car depth: 550 mm

**Maximum car area 1,65 m²**

Width and depth of car dimensions in 5mm steps

		Shaft width (SW)								
		1250	1300	1350	1400	1450	1500	1550	1570	+
Shaft depth (SD)	1655									
	1600									
	1550									
	1500									
	1450									
	1400									
	1350									
	1300									
	1250									
	1200									
	1150									
	1100									
1050										
1005										
		1250	1300	1350	1400	1450	1500	1550	1570	+

**Minimum pit areas**

- ▶ 1050 mm
- ▶ Minimum reduced pit EN 81-21: 350 mm
- ▶ 320 mm subject to a technical study

Clear opening (C/O) Pit >= 750mm	C/O 700	•			••	
	C/O 750	•			••	
	C/O 800	•		••		
	C/O 850		•		••	
	C/O 900			•		••

Clear opening (C/O) Pit <= 749mm	C/O 700	•			••		
	C/O 750				••		
	C/O 800		•		••		
	C/O 850			•		••	
	C/O 900				•		••

**Minimum headroom requirements (car height 2175 mm)**

- — 4600 mm
- All others 3600 mm

**Load**

- 225Kg
- 320Kg
- 375Kg
- 450Kg
- 525Kg
- 630Kg

**Door frame width**

- Door frame width (DFW): 90 mm
- Door frame width (DFW): 120 mm

Mechanical position

## Side

Doors

## 2 panel side opening Hydra

Door mounting position

## Mounted on landings

Entrance

## Single 0°

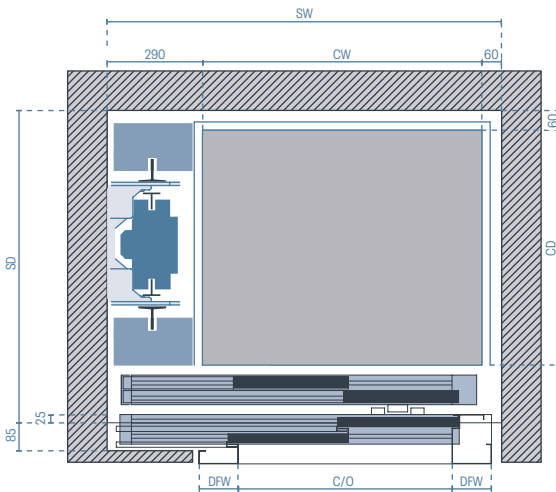

## Car dimensions

### CALCULATION OF CAR DIMENSIONS

**Car width** = Shaft width - 350 mm

**Car depth** = Shaft depth - 235 mm

- ▶ Maximum car width: 1200 mm
- ▶ Minimum car width C/O 600: 715 mm
- ▶ Minimum car width C/O 650: 765 mm
- ▶ Minimum car width C/O 700: 815 mm
- ▶ Minimum car width C/O 750: 935 mm
- ▶ Minimum car width C/O 800: 985 mm
- ▶ Minimum car width C/O 850: 1085 mm
- ▶ Minimum car width C/O 900: 1145 mm
- ▶ Maximum car depth: 1450 mm
- ▶ Minimum car depth: 715 mm

**Maximum car area 1,65 m<sup>2</sup>**

Width and depth of car dimensions in 5mm steps

		Shaft width (SW)									
		1200	1250	1300	1350	1400	1450	1500	1550	+	
Shaft depth (SD)	+										+
	1685										1685
	1650										1650
	1600										1600
	1550										1550
	1500										1500
	1450										1450
	1400										1400
	1350										1350
	1300										1300
	1250										1250
	1200										1200
1150										1150	
1100										1100	
		1200	1250	1300	1350	1400	1450	1500	1550	+	

Clear opening (C/O) Pit >= 750mm	C/O 600									••
	C/O 650									••
	C/O 700									••
	C/O 750									••
	C/O 800									••
	C/O 850									••
	C/O 900									••

Clear opening (C/O) Pit <= 749mm	C/O 650									••
	C/O 700									••
	C/O 750									••
	C/O 800									••
	C/O 850									••
	C/O 900									••

\* Minimum clear opening (C/O) = 650mm

## Minimum pit areas

1350 mm
<b>All others</b> 1050 mm

- ▶ Minimum reduced pit EN 81-21: 350 mm
- ▶ 320 mm subject to a technical study

## Minimum headroom requirements (car height 2175 mm)

- ▶ 3600 mm

## Load

225Kg	320Kg	375Kg	450Kg	525Kg	630Kg
-------	-------	-------	-------	-------	-------

## Door frame width

- Door frame width (DFW): 120 mm

Mechanical position

## Side

Doors

## 2 panel side opening Hydra

Door mounting position

## Mounted on landings

Entrance

## Through car 180°

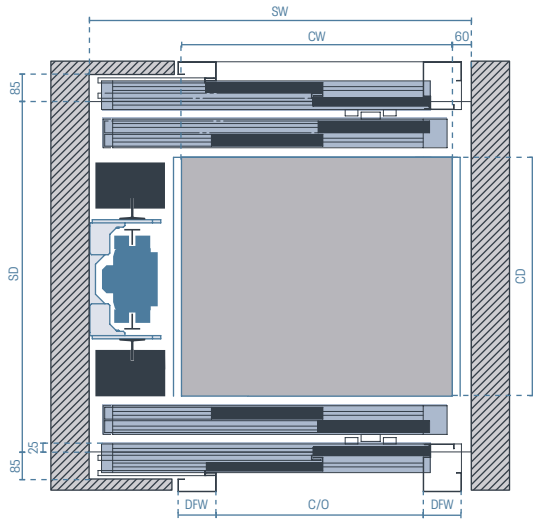

## Car dimensions

### CALCULATION OF CAR DIMENSIONS

**Car width** = Shaft width - 350 mm

**Car depth** = Shaft depth - 350 mm

- ▶ Maximum car width: 1200 mm
- ▶ Minimum car width C/O 600: 715 mm
- ▶ Minimum car width C/O 650: 765 mm
- ▶ Minimum car width C/O 700: 815 mm
- ▶ Minimum car width C/O 750: 935 mm
- ▶ Minimum car width C/O 800: 985 mm
- ▶ Minimum car width C/O 850: 1085 mm
- ▶ Minimum car width C/O 900: 1145 mm
- ▶ Maximum car depth: 1450 mm
- ▶ Minimum car depth: 750 mm

**Maximum car area 1,65 m<sup>2</sup>**

Width and depth of car dimensions in 5mm steps

		Shaft width (SW)								
		1200	1250	1300	1350	1400	1450	1500	1550	+
Shaft depth (SD)	1800									
	1750									
	1700									
	1650									
	1600									
	1550									
	1500									
	1450									
	1400									
	1350									
1300										
1250										
1200										
1150										
1100										

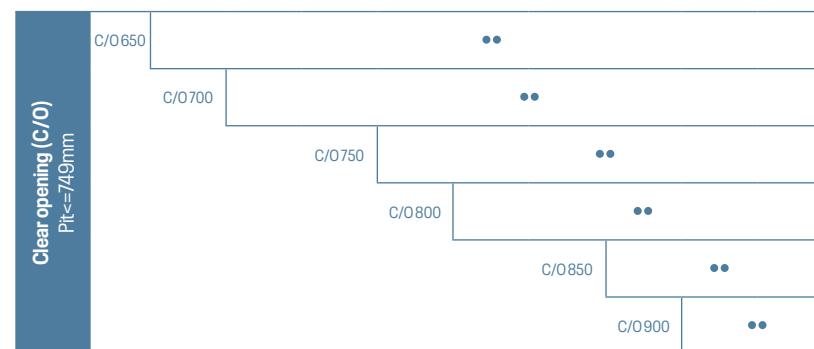
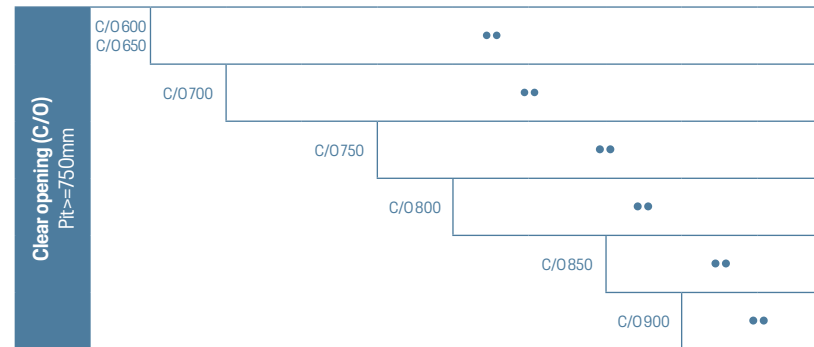

\* Minimum clear opening (C/O) = 650mm

## Minimum pit areas

1350 mm
<b>All others</b> 1050 mm

- ▶ Minimum reduced pit EN 81-21: 350 mm
- ▶ 320 mm subject to a technical study

## Minimum headroom requirements (car height 2175 mm)

- ▶ 3600 mm

## Load

225Kg	320Kg	375Kg	450Kg	525Kg	630Kg
-------	-------	-------	-------	-------	-------

## Door frame width

- Door frame width (DFW): 120 mm

Mechanical position

## Side

Doors

## 2 panel side opening Hydra

Door mounting position

## Mounted on landings

Entrance

## Through car 90°

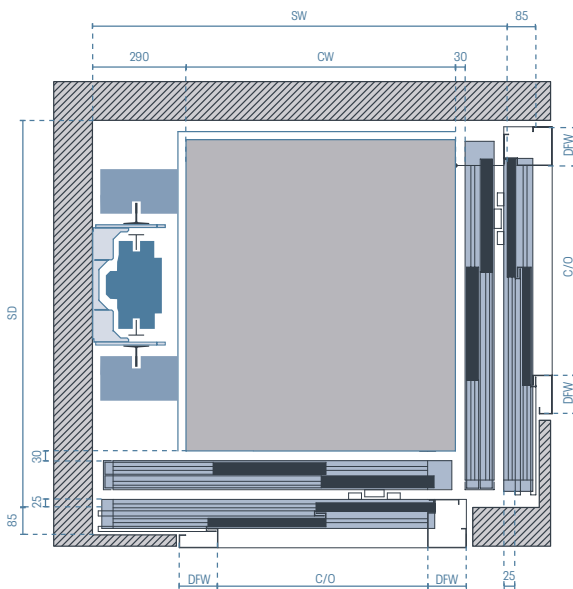

Shaft depth (SD)	Shaft width (SW)							
	1300	1350	1400	1450	1500	1550	1600	1665
1685								1685
1650								1650
1600								1600
1550								1550
1500								1500
1450								1450
1400								1400
1350								1350
1300								1300
1250								1250
1200								1200

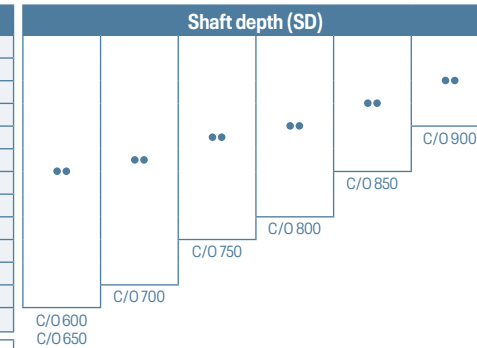

Clear opening (C/O) Pit >= 750mm	Shaft width (SW)							
	1300	1350	1400	1450	1500	1550	1600	1665
C/O 600								
C/O 650								
C/O 700								
C/O 750								
C/O 800								
C/O 850								
C/O 900								

Clear opening (C/O) Pit <= 749mm	Shaft width (SW)							
	1300	1350	1400	1450	1500	1550	1600	1665
C/O 600								
C/O 650								
C/O 700								
C/O 750								
C/O 800								
C/O 850								
C/O 900								

## Car dimensions

### CALCULATION OF CAR DIMENSIONS

**Car width** = Shaft width - 465 mm

**Car depth** = Shaft depth - 235 mm

- ▶ Maximum car width: 1200 mm
- ▶ Minimum car width C/O 600 (0°): 700 mm
- ▶ Minimum car width C/O 650 (0°): 765 mm
- ▶ Minimum car width C/O 700 (0°): 825 mm
- ▶ Minimum car width C/O 750 (0°): 925 mm
- ▶ Minimum car width C/O 800 (0°): 975 mm
- ▶ Minimum car width C/O 850 (0°): 1075 mm
- ▶ Minimum car width C/O 900 (0°): 1140 mm
- ▶ Minimum car depth C/O 600 (90°): 850 mm
- ▶ Minimum car depth C/O 650 (90°): 900 mm
- ▶ Minimum car depth C/O 700 (90°): 960 mm
- ▶ Minimum car depth C/O 750 (90°): 1060 mm
- ▶ Minimum car depth C/O 800 (90°): 1110 mm
- ▶ Minimum car depth C/O 850 (90°): 1195 mm
- ▶ Minimum car depth C/O 900 (90°): 1295 mm
- ▶ Maximum car depth: 1450 mm

**Maximum car area 1,65 m²**

Width and depth of car dimensions in 5mm steps

## Minimum pit areas

- ▶ 1050 mm
- ▶ Minimum reduced pit EN 81-21: 350 mm
- ▶ 320 mm subject to a technical study

## Minimum headroom requirements (car height 2175 mm)

- ▶ 3600 mm

## Load

320Kg 375Kg 450Kg 525Kg 630Kg

## Door frame width

- Door frame width (DFW): 120 mm



Mechanical position

## Side

Doors

## 3 panel side opening Hydra

Door mounting position

## Mounted on landings

Entrance

## Single 0°

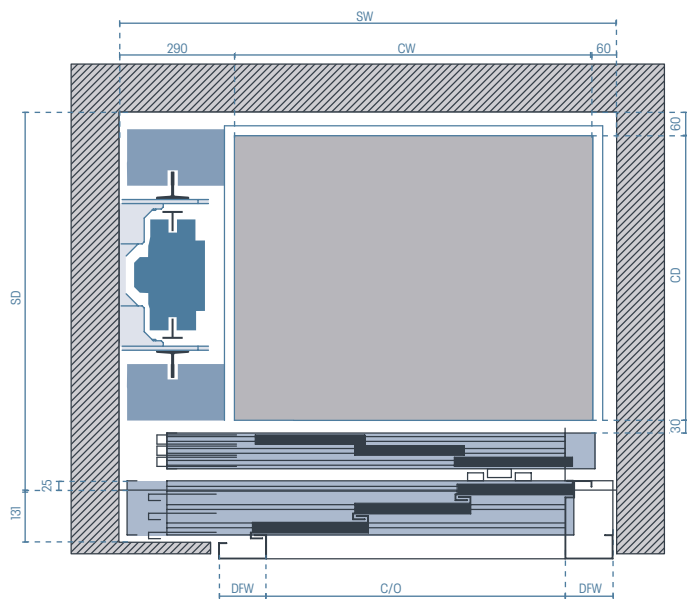

## Car dimensions

### CALCULATION OF CAR DIMENSIONS

**Car width** = Shaft width - 350 mm

**Car depth** = Shaft depth - 235 mm

- ▶ Maximum car width: 1200 mm
- ▶ Minimum car width: Clear opening + 50 mm
- ▶ Maximum car depth: 1450 mm
- ▶ Minimum car depth: 715 mm

**Maximum car area 1,65 m<sup>2</sup>**

Width and depth of car dimensions in 5mm steps

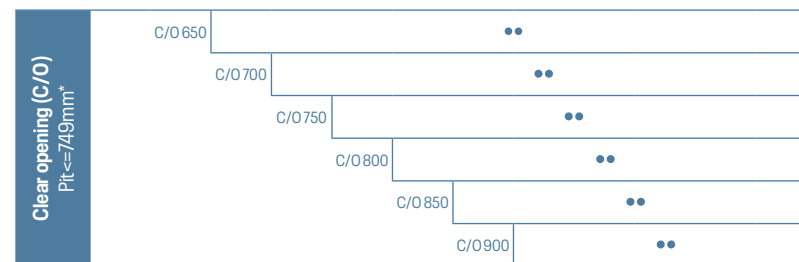
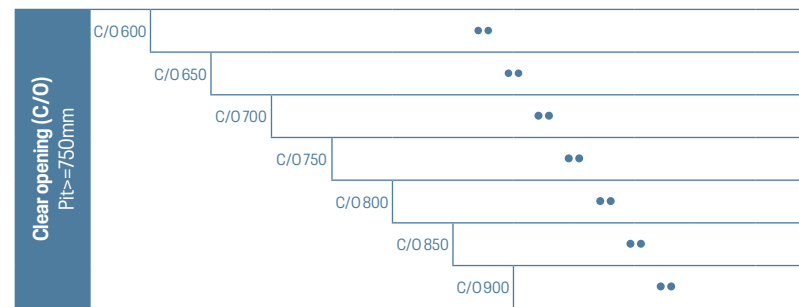
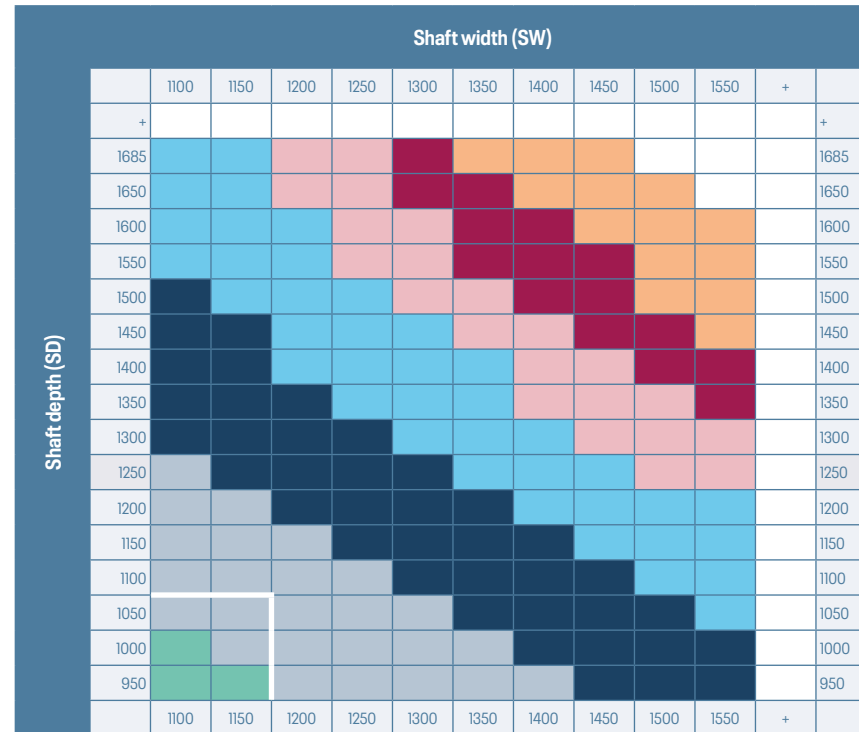

\* Minimum clear opening (C/O) = 650mm

## Minimum pit areas

1350 mm
All others 1050 mm

- ▶ Minimum reduced pit EN 81-21: 350 mm
- ▶ 320 mm subject to a technical study

## Minimum headroom requirements (car height 2175 mm)

- ▶ 3600 mm

## Load

180Kg	225Kg	320Kg	375Kg	450Kg	525Kg	630Kg
-------	-------	-------	-------	-------	-------	-------

## Door frame width

- Door frame width (DFW): 120 mm

## Mechanical position

### Side

### Doors

## 3 panel side opening Hydra

### Door mounting position

## Mounted on landing

### Entrance

## Through car 90°

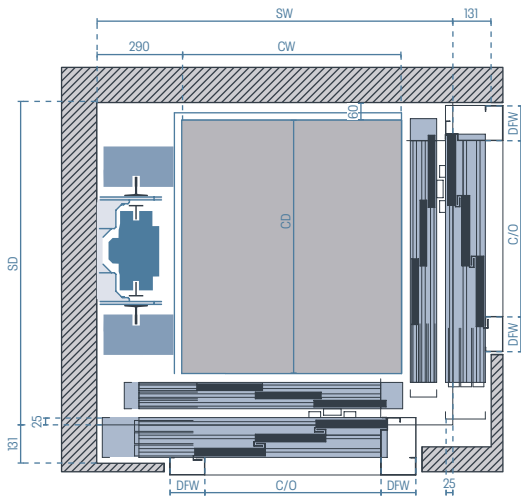

## Car dimensions

### CALCULATION OF CAR DIMENSIONS

**Car width** = Shaft width - 465 mm

**Car depth** = Shaft depth - 235 mm

- ▶ Maximum car width: 1200 mm
- ▶ Minimum car width: Clear opening 0° + 150 mm
- ▶ Maximum car depth: 1450 mm
- ▶ Minimum car depth: Clear opening 90° + 230 mm

**Maximum car area 1,65 m<sup>2</sup>**

Width and depth of car dimensions in 5mm steps

Shaft depth (SD)	Shaft width (SW)										
	1215	1265	1315	1365	1415	1465	1515	1565	1615	1665	
+											+
1685											1685
1650											1650
1600											1600
1550											1550
1500											1500
1450											1450
1400											1400
1350											1350
1300											1300
1250											1250
1200											1200
1150											1150
1100											1100
	1215	1265	1315	1365	1415	1465	1515	1565	1615	1665	

Clear opening (C/O) Pit >= 750mm	Shaft width (SW)									
	1215	1265	1315	1365	1415	1465	1515	1565	1615	1665
C/O 600										
C/O 650										
C/O 700										
C/O 750										
C/O 800										
C/O 850										
C/O 900										

Clear opening (C/O) Pit <= 749mm	Shaft width (SW)									
	1215	1265	1315	1365	1415	1465	1515	1565	1615	1665
C/O 650										
C/O 700										
C/O 750										
C/O 800										
C/O 850										
C/O 900										

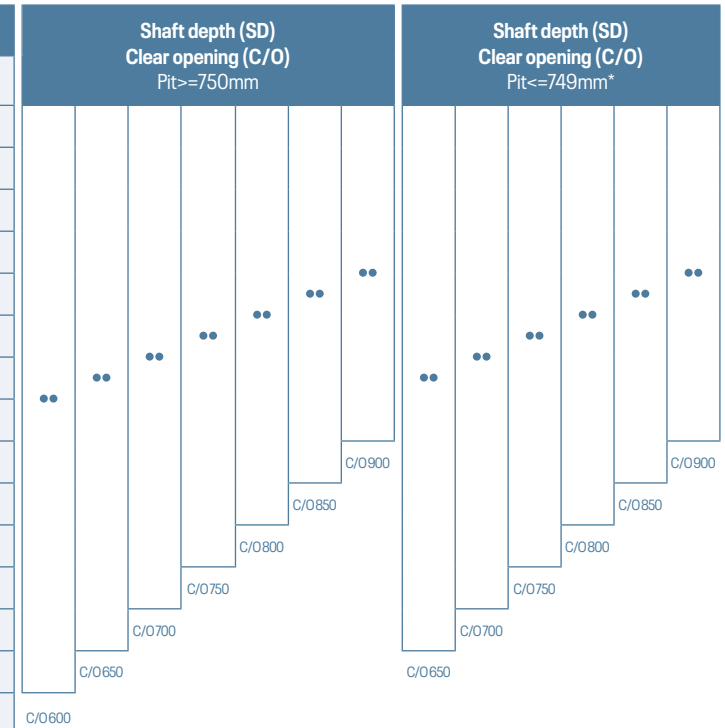

## Minimum pit areas

- ▶ 1050 mm
- ▶ Minimum reduced pit EN 81-21: 350 mm
- ▶ 320 mm subject to a technical study

## Minimum headroom requirements (car height 2175 mm)

- ▶ 3600 mm

## Load

225Kg 320Kg 375Kg 450Kg 525Kg 630Kg

## Door frame width

- Door frame width (DFW): 120 mm



Mechanical position

## Side

Doors

## 3 panel side opening Hydra

Door mounting position

## Mounted on landing

Entrance

## Through car 180°

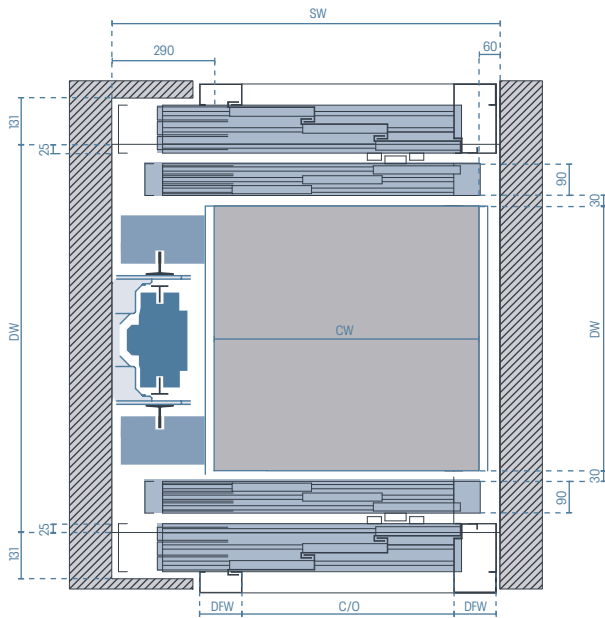

## Car dimensions

### CALCULATION OF CAR DIMENSIONS

**Car width** = Shaft width - 350 mm

**Car depth** = Shaft depth - 350 mm

- ▶ Maximum car width: 1200 mm
- ▶ Minimum car width: Clear opening + 50 mm
- ▶ Maximum car depth: 1450 mm
- ▶ Minimum car depth: 750 mm

**Maximum car area 1,65 m<sup>2</sup>**

Width and depth of car dimensions in 5mm steps

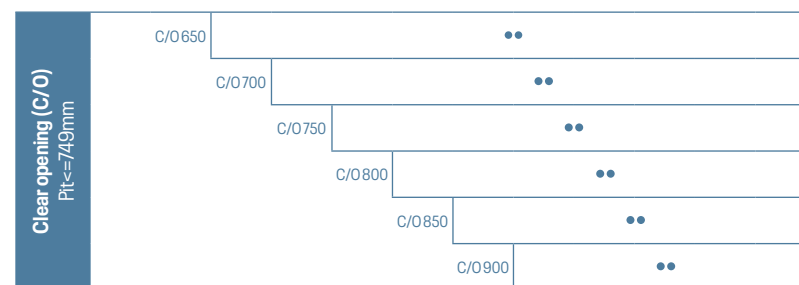
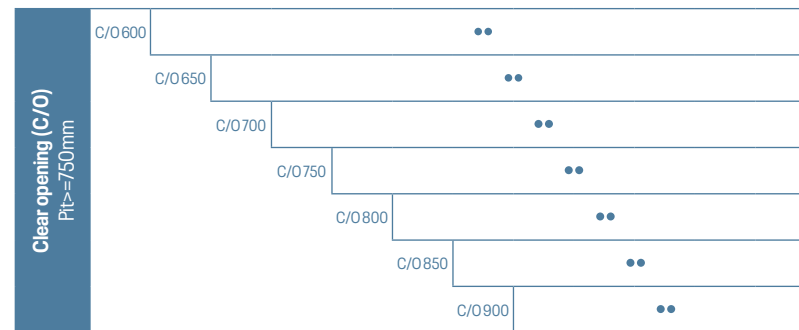
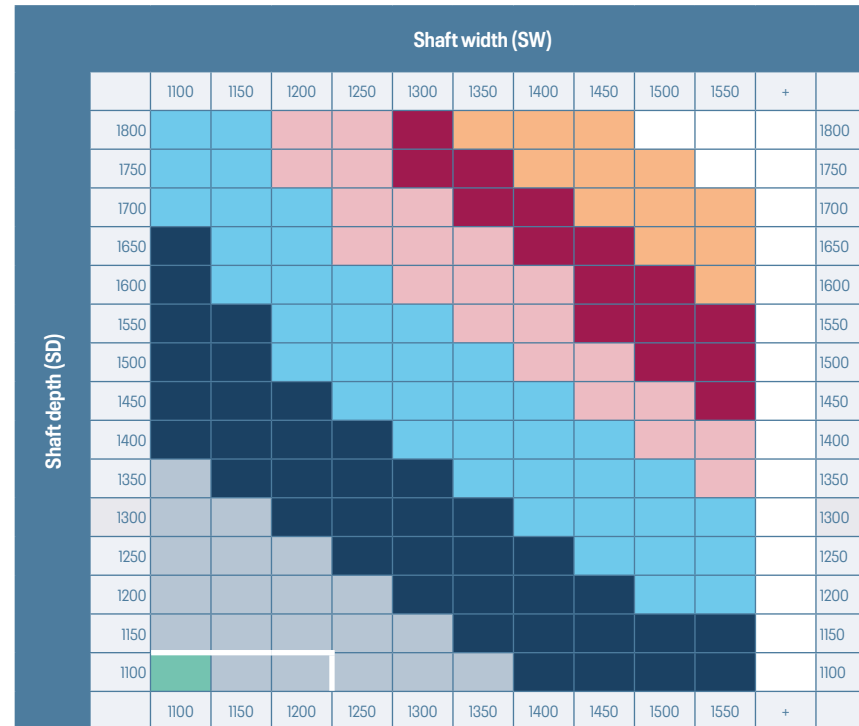

## Minimum pit areas

1350 mm
All others 1050 mm

- ▶ Minimum reduced pit EN 81-21: 350 mm
- ▶ 320 mm subject to a technical study

## Minimum headroom requirements (car height 2175 mm)

- ▶ 3600 mm

## Load



## Door frame width

- Door frame width (DFW): 120 mm



Mechanical position

## Side

Doors

## 4 panel central opening Hydra

Door mounting position

## Mounted on landings

Entrance

## Single 0°

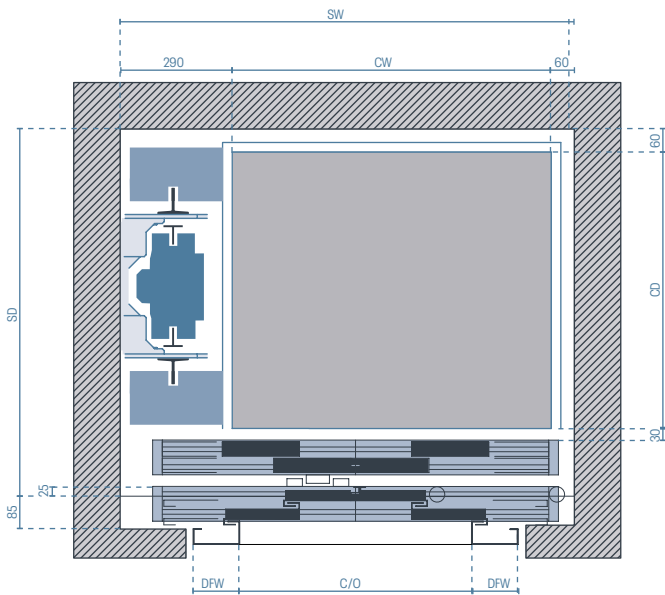

## Car dimensions

### CALCULATION OF CAR DIMENSIONS

**Car width** = Shaft width - 350 mm

**Car depth** = Shaft depth - 235 mm

- ▶ Maximum car width: 1200 mm
- ▶ Minimum car width: Clear opening + 50 mm
- ▶ Maximum car depth: 1450 mm
- ▶ Minimum car depth: 715 mm

**Maximum car area 1,65 m²**

Width and depth of car dimensions in 5mm steps

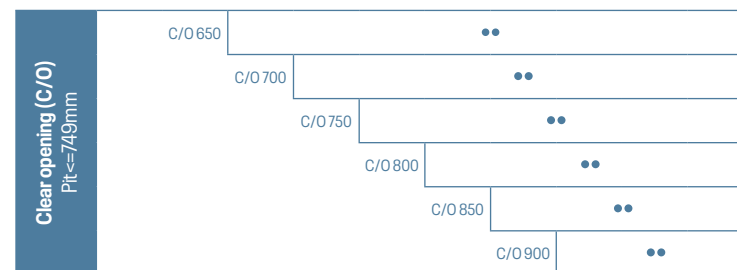
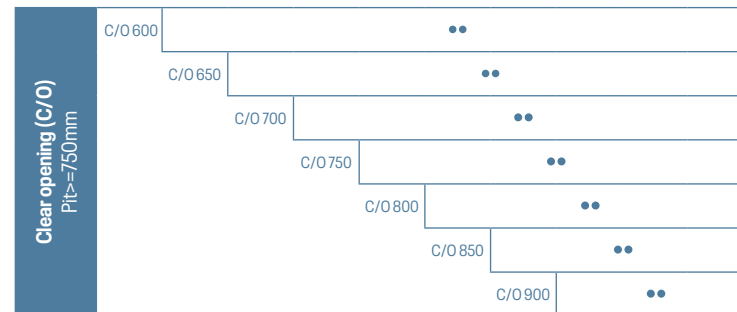
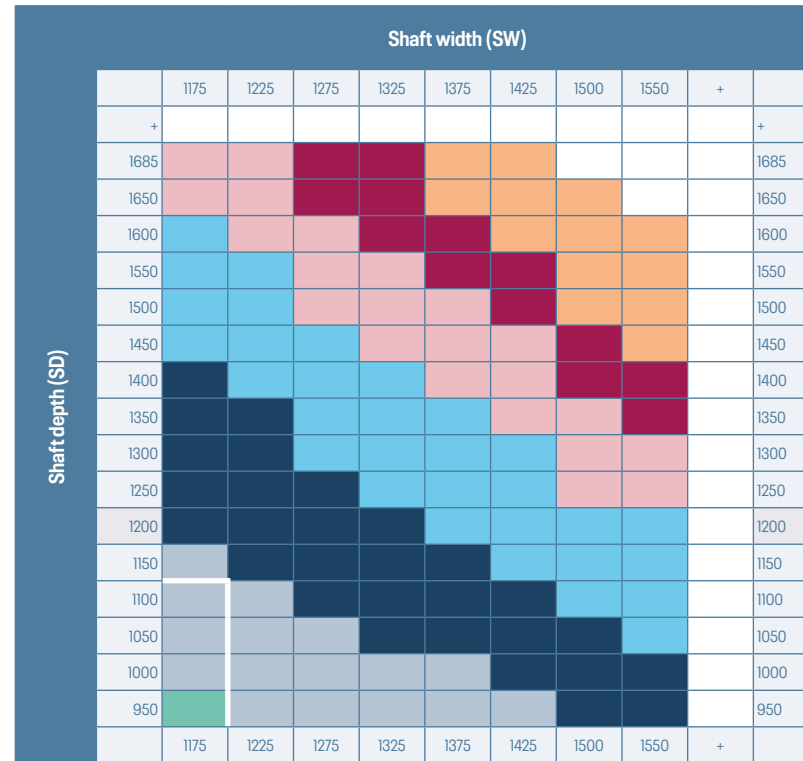

## Minimum pit areas

—	1350 mm
All others	1050 mm

- ▶ Minimum reduced pit EN 81-21: 350 mm
- ▶ 320 mm subject to a technical study

## Minimum headroom requirements (car height 2175 mm)

- ▶ 3600 mm

## Load

180Kg	225Kg	320Kg	375Kg	450Kg	525Kg	630Kg
-------	-------	-------	-------	-------	-------	-------

## Door frame width

- Door frame width (DFW): 120 mm

Mechanical position

## Side

Doors

## 4 panel central opening Hydra

Door mounting position

## Mounted on landings

Embarque

## Through car 180°

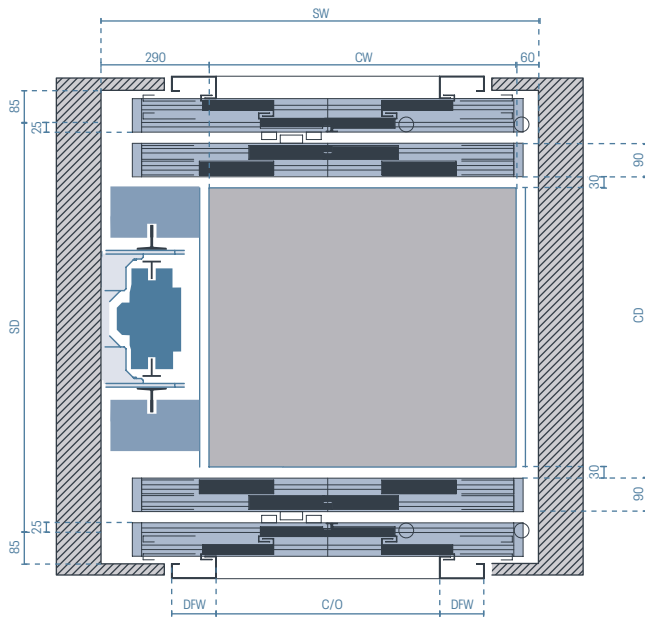

## Car dimensions

### CALCULATION OF CAR DIMENSIONS

**Car width** = Shaft width - 350 mm

**Car depth** = Shaft depth - 350 mm

- ▶ Maximum car width: 1200 mm
- ▶ Minimum car width: Clear opening + 50 mm
- ▶ Maximum car depth: 1450 mm
- ▶ Minimum car depth: 750 mm

**Maximum car area 1,65 m<sup>2</sup>**

Width and depth of car dimensions in 5mm steps

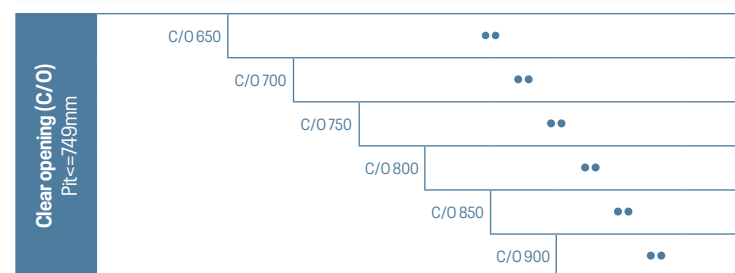
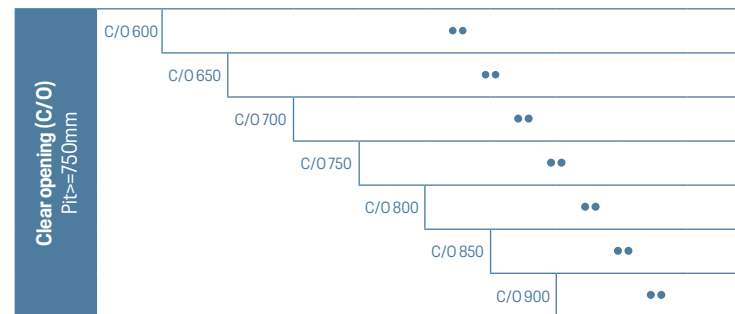
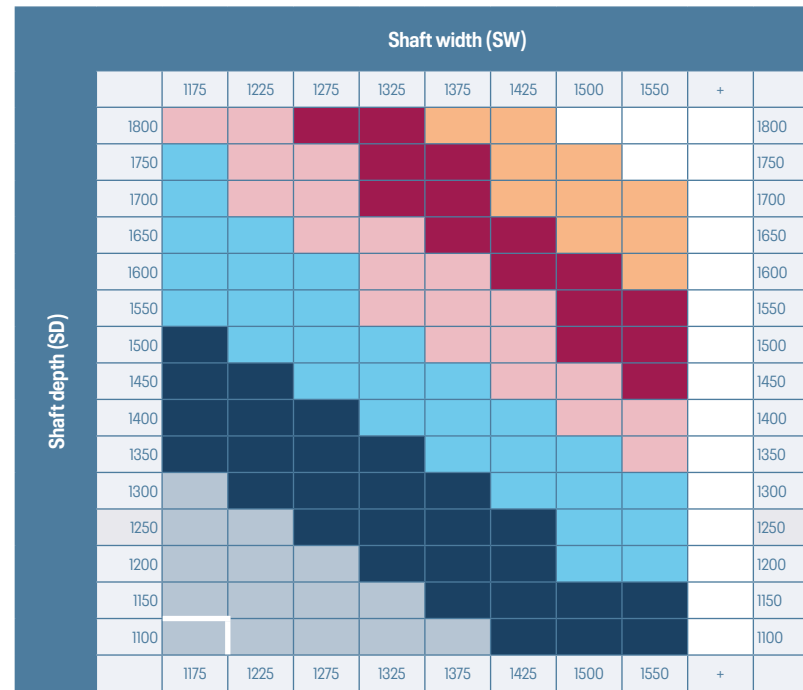

## Minimum pit areas

1350 mm
<b>All others</b> 1050 mm

- ▶ Minimum reduced pit EN 81-21: 350 mm
- ▶ 320 mm subject to a technical study

## Minimum headroom requirements (car height 2175 mm)

- ▶ 3600 mm

## Load

225Kg	320Kg	375Kg	450Kg	525Kg	630Kg
-------	-------	-------	-------	-------	-------

## Door frame width

- Door frame width (DFW): 120 mm



Mechanical position  
**Rear mounted**

Doors  
**4 panel central opening Hydra**

Door mounting position  
**Mounted on landings**

Entrance  
**Single 0°**

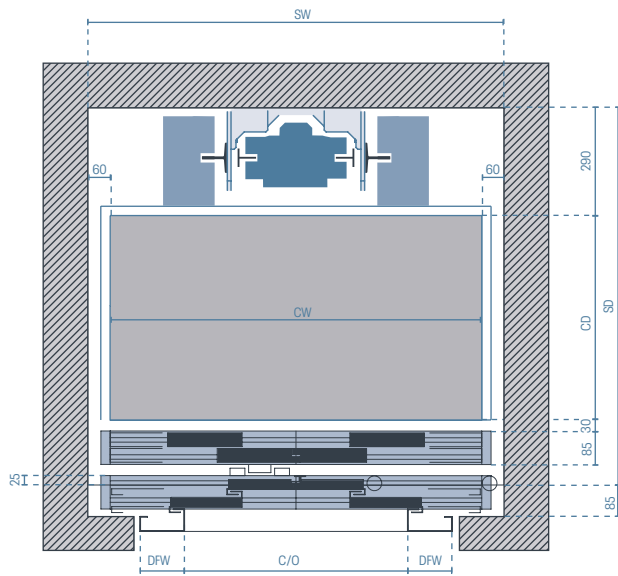

**Car dimensions**

CALCULATION OF CAR DIMENSIONS	
<b>Car width</b>	= Shaft width - 120 mm
<b>Car depth</b>	= Shaft depth - 465 mm

- ▶ Maximum car width: 1450 mm
- ▶ Minimum car width: Clear opening + 30 mm
- ▶ Maximum car depth: 1200 mm
- ▶ Minimum car depth: 550 mm

**Maximum car area 1,65 m²**

Width and depth of car dimensions in 5mm steps

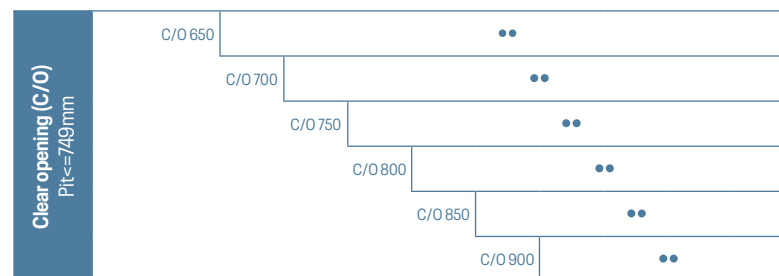
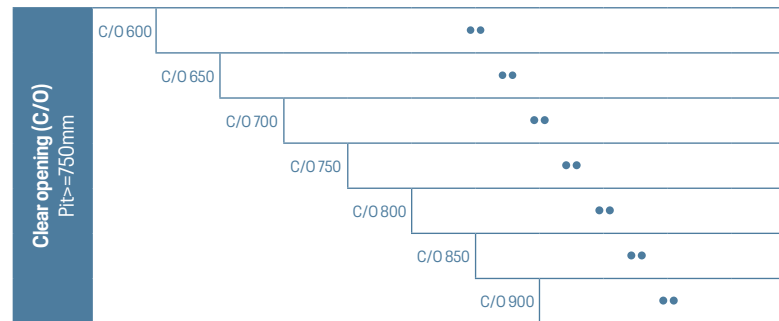
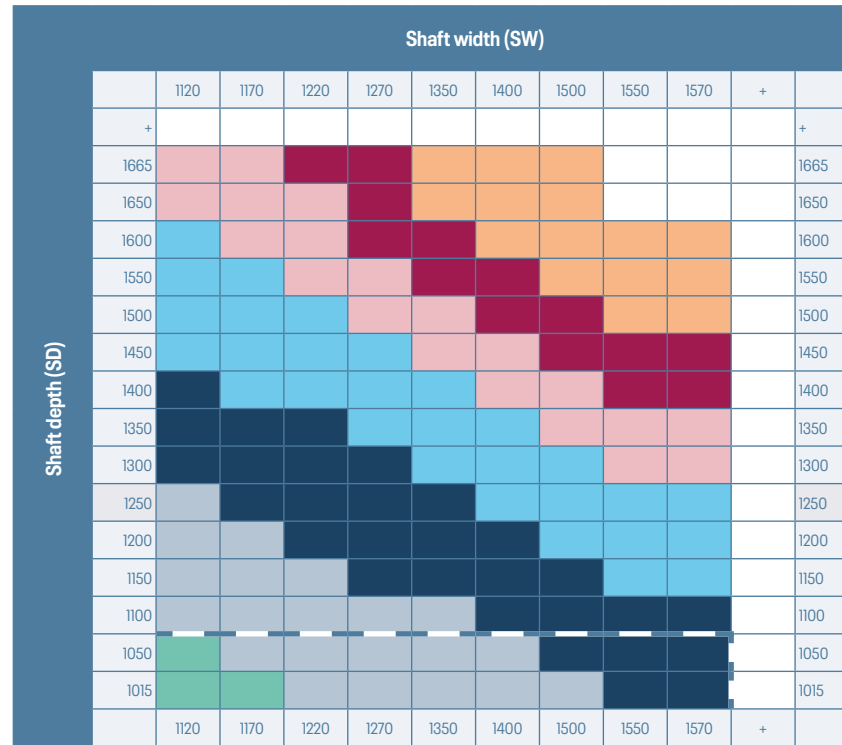

**Minimum pit areas**

- ▶ 1050 mm
- ▶ Minimum reduced pit EN 81-21: 350 mm
- ▶ 320 mm subject to a technical study

**Minimum headroom requirements (car height 2175 mm)**

—	4600 mm
All others	3600 mm

**Load**



**Door frame width**

- Door frame width (DFW): 120 mm

# One product Configurator:

## Unlimited possibilities.



### Reduce quote times

24/7 online quotations and full working drawings.



### Unique customer experience

A truly integrated and automated system.



### Integration with 3<sup>rd</sup> party software

.Xml output.



### Simplify sales

All your projects in one space.



### Error proof

Our fully programmed system ensures your configuration is fully compliant.



### Full project control

.Dwg and .PDF full manufacturing drawings.



### Reduced Order Cycle Times

Unlimited General Arrangement Drawings and modifications.



### Future-proof

Continuous improvements with future updates.



### Online Technical Office

Future integration with your personalised IMEM portal.



### Full IMEM product range

Our goal is to include all product solutions online.

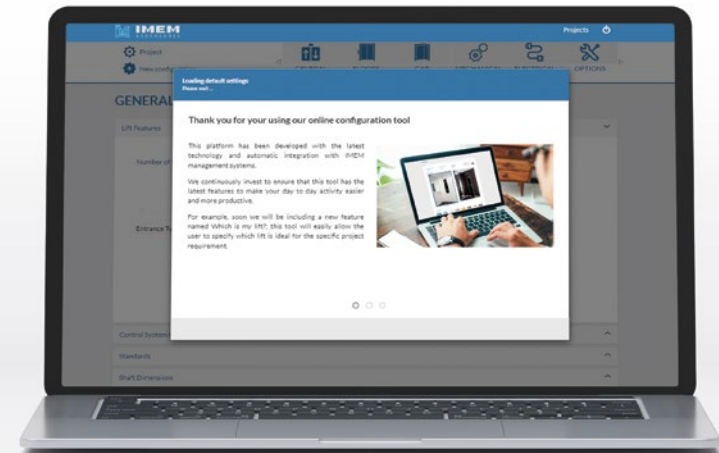
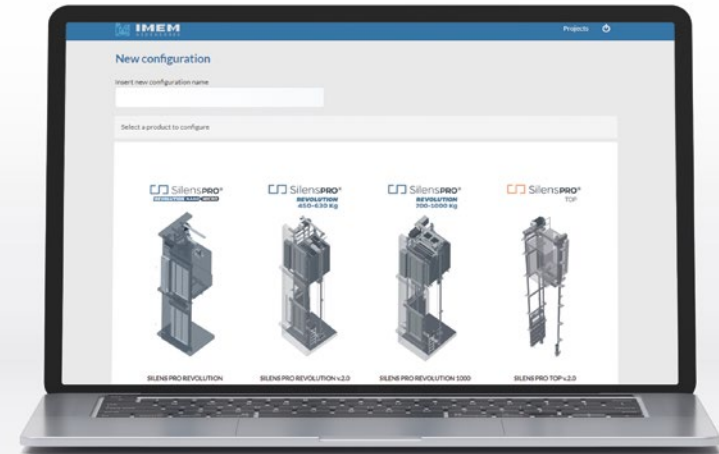



#### EXPORT DEPARTMENT

C/ Adarzo 167-B · 39011 Peñacastillo · Santander, Spain

**Tel:** (00 34) 942 34 60 20 **Fax:** (00 34) 942 35 53 64 **E-mail:** [comex@imem.com](mailto:comex@imem.com)



ER-0426/1997



GA-2008/0458



SST-0008/2008



Made in Europe

[www.imem.com](http://www.imem.com)



May 2023